

Product & Price

A product price list in EUR from **Kortsystem**
valid as of **september 1st 2024**

Kortsystem

At Kortsystem we work with labelling systems in four different product areas: warehouse, production, retail and industri. We develop and manufacture all of our products in Gislaved. These consist of labels, signs and holders that we sell primarily in Northern Europe.

Kortsystem aims to be consistently associated with high quality, at all stages of the customer relationship. We do this by constantly improving our internal processes so that we always fulfil our customer's requirements.

We also believe that a high level of involvement in the process as well as a high level of service contribute greatly to our ability to deliver projects on time, at the right price and quality.

Terms and conditions

- All prices are net and ex works.
- Payments terms are 20 days net from invoice date.
- Any complaints has to be made within 8 days of receiving the goods.
- Any returns needs to be approved by Kortsystem.
- Product and price subject to change.

Product information

The dimensions that are used in our articles describes the size of the appropriate label, the label holder dimensions are not given in the article name.

More information about our products can be found on our website where you also can order samples of our products.

You are always welcome to contact us at Kortsystem.

Kortsystem i Gislaved AB

Mailbox | Box 277, SE-332 25 Gislaved
Visit | Verkstadsgatan 6, SE-332 35 Gislaved
Telephone | +46 (0)371-22 24 44
E-mail | info@kortsystem.se
Website | www.kortsystem.se
VAT | SE556232928301

QR-code for product groups

Each product group has a QR-code that leads to our website, there you can find more information and order our products.

Links inside the PDF-file

QR-code for each product group is a clickable link if you are reading this in its PDF-format.

No need to scan the QR-code, all you need to do is click.

Product News

New products and a short description that can be found on this price list is available at page 59.

You can find us on social media where we post some news, activities and videos related to our company.

Search **Kortsystem** or scan QR-code:



- Label holders
 - Pallet racking | 05
 - Shelf | 11
 - Post | 13
 - Plastic crate | 14
 - Wire shelf | 14
 - Dividers | 15
 - Assorted complement | 16
- Labels
 - Cardboard | 19
 - (Permanent) Vinyl | 21
 - (Removeable) Vinyl | 23
 - Magnetic | 24
 - Freezer | 25
 - Low energi | 26
 - Floor | 27
 - Asphalt | 28
 - Stencil | 28
 - (Removeable) Floor | 29
- Rolls
 - Floor | 32
 - Magnetic | 33
 - Tape | 33
- Pipe marking | 34
- Safety marking | 35
- Aisle signs
 - Assembled | 39
 - Hard plastic | 40
 - Aluminum | 41
 - Angled holder | 41
 - Ceiling & Gates | 42
 - Unassembled | 43
 - Aisle holder | 43
- Information holder
 - Clear | 45
 - Coloured frame | 45
 - Coloured frame open | 46
 - Floor | 47
 - Plastic pockets | 48
 - Pallet footing | 49
- Card holders
 - Pallet frame | 51
 - Raised | 52
 - Signaling | 52
 - Plastic cover | 53
- Menu holders | 55
- Lean Production | 56
- Accessories | 58

Label holders

When choosing a label holder, readability, working methods, ergonomics and the environment are important. Our holders are available in multiple sizes, flat or angled, open or protected, can be obtained with self-adhesive tape, magnet or self-adhesive foam and are adapted to the markets various pallet rackings, shelf profiles, poles/posts, plastic trays, etc.

Products listed in our price list are standard sizes and are available for immediate delivery in most cases. As Kortsystem is a manufacturing company, it is possible to get other sizes than standard. Contact us if you are interested and want more information.

Our label holders are manufactured from a clear transparent APET that is 0.5 mm in thickness

- Withstands temperatures up to 70°C
- High chemical resistance
- Abrasion resistance
- Bendable
- Suitable for direct contact with food
- Not flammable

Our double-sided self-adhesive tape (illustrated in red ) is a permanent acrylic with an adhesive strength of 20 N/10 mm. The thickness is 205 µ.

Our magnetic tape (illustrated with gray ) is isotropic with a magnetic strength of 75 g/cm². The thickness is 1500 µ.

Our foam self-adhesive tape (illustrated with blue ) is reinforced modified acrylic with an adhesive strength of 6 N / 10 mm. The thickness is 1100 µ and has a carrier consisting of PE foam.

To clarify form and function, we have illustrations that exaggerates its thickness. This should give a clear indication of differences between different holders and which functions they provide. The dimensions given in our products describe the size of the label that the holder fits and not the physical dimensions of the holder.

Example of EBA/EBB as a closed holder to protect the label completely. Good for a more permanent installations as well protection against dust and liquid spills.

Opposite holder is SBA/SBB which is an open front and shorter back and facilitates label changing. Good for a fluid flow in a warehouse/store where information needs to be exchanged more often.

As standard, Kortsystem has two different angles on our label holders, 27 or 45 degrees. Perfect for angled profiles. If a rack is very high, you can choose an even greater angle, 72 degrees, the holder then tilts more and increases the readability.

We also sell cardboard paper that fits all our standard holders, printed or unprinted. More information about these can be found on page 19

EH & EHB

With open top for easy label mounting



≡ 50 pcs/pack
■ EH - Self-adhesive
■ EHB - Magnetic

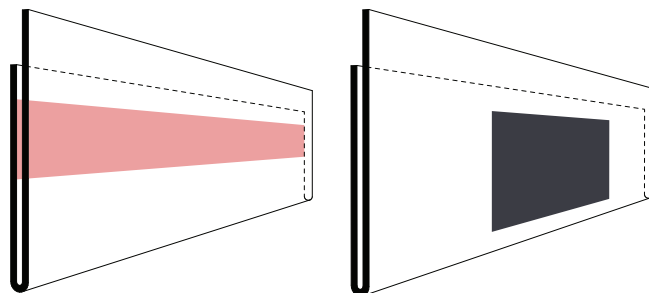

| Art.no (L x H) | 1-3 pack | 4-9 pack | 10-24 pack | 25-49 pack | 50+ pack |
|----------------|----------|----------|------------|------------|----------|
| EH 210-30 F | 39,36 | 36,17 | 35,11 | 34,04 | 32,45 |
| EH 210-40 F | 40,96 | 37,77 | 36,70 | 35,64 | 34,04 |
| EH 210-50 F | 42,55 | 39,36 | 38,30 | 37,23 | 35,64 |
| EH 210-60 F | 44,15 | 40,96 | 39,89 | 38,83 | 37,23 |
| EH 210-75 F | 50,53 | 47,34 | 46,28 | 45,21 | 43,62 |
| EH 210-100 F | 55,74 | 52,55 | 50,96 | 49,89 | 48,30 |
| EHB 210-30 F | 60,64 | 57,45 | 56,38 | 55,32 | 53,72 |
| EHB 210-40 F | 63,83 | 60,64 | 59,57 | 58,51 | 56,91 |
| EHB 210-50 F | 65,96 | 62,77 | 61,70 | 60,64 | 59,04 |
| EHB 210-60 F | 67,55 | 64,36 | 63,30 | 62,23 | 60,64 |
| EHB 210-75 F | 77,66 | 74,47 | 73,40 | 72,34 | 70,74 |
| EHB 210-100 F | 82,98 | 79,79 | 78,72 | 77,66 | 76,06 |

EH & EHB 105

With a length of 105 mm for shorter labels

≡ Price per unit

| Art.no (L x H) | 1-24 ea. | 25-99 ea. | 100-249 ea. | 250-499 ea. | 500+ ea. |
|----------------|----------|-----------|-------------|-------------|----------|
| EH 105-30 | 2,07 | 1,27 | 0,86 | 0,63 | 0,54 |
| EH 105-40 | 2,11 | 1,30 | 0,89 | 0,65 | 0,57 |
| EH 105-50 | 2,13 | 1,32 | 0,91 | 0,67 | 0,60 |
| EH 105-60 | 2,14 | 1,33 | 0,93 | 0,68 | 0,61 |
| EH 105-75 | 2,26 | 1,45 | 1,05 | 0,81 | 0,72 |
| EH 105-100 | 2,40 | 1,61 | 1,20 | 0,96 | 0,87 |
| EHB 105-30 | 2,83 | 1,80 | 1,28 | 0,97 | 0,86 |
| EHB 105-40 | 2,88 | 1,85 | 1,33 | 1,02 | 0,91 |
| EHB 105-50 | 2,90 | 1,87 | 1,35 | 1,04 | 0,94 |
| EHB 105-60 | 2,93 | 1,88 | 1,36 | 1,05 | 0,95 |
| EHB 105-75 | 3,02 | 1,98 | 1,46 | 1,15 | 1,05 |
| EHB 105-100 | 3,06 | 2,02 | 1,51 | 1,19 | 1,10 |

EHB FR

With a stapled magnet, suitable for freezers

≡ Price per unit

| Art.no (L x H) | 1-24 ea. | 25-99 ea. | 100-249 ea. | 250-499 ea. | 500+ ea. |
|----------------|----------|-----------|-------------|-------------|----------|
| EHB 210-50 FR | 6,63 | 4,31 | 3,14 | 2,45 | 2,21 |
| EHB 210-60 FR | 6,65 | 4,33 | 3,16 | 2,47 | 2,23 |
| EHB 210-75 FR | 6,83 | 4,50 | 3,34 | 2,64 | 2,40 |

EBA & EBB

A closed holder that protects against dirt



≡ 50 pcs/pack
■ EBA - Self-adhesive
■ EBB - Magnetic

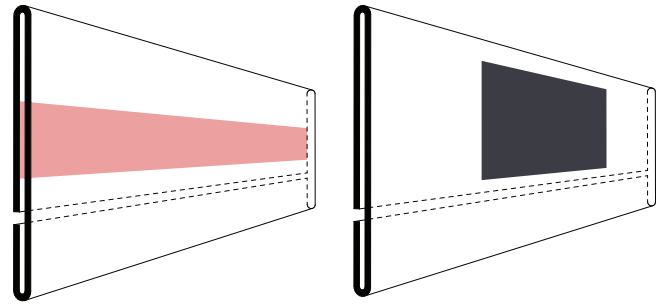

| Art.no (L x H) | 1-3 pack | 4-9 pack | 10-24 pack | 25-49 pack | 50+ pack |
|----------------|----------|----------|------------|------------|----------|
| EBA 210-30 F | 57,98 | 54,79 | 53,72 | 53,19 | 50,53 |
| EBA 210-40 F | 59,57 | 56,38 | 55,32 | 54,79 | 52,13 |
| EBA 210-50 F | 61,17 | 57,98 | 56,91 | 56,38 | 53,72 |
| EBA 210-60 F | 61,70 | 58,51 | 57,45 | 56,91 | 54,26 |
| EBA 210-75 F | 64,36 | 60,64 | 59,57 | 59,04 | 56,38 |
| EBA 210-100 F | 67,55 | 63,83 | 62,23 | 61,70 | 59,04 |
| EBB 210-30 F | 71,28 | 68,09 | 67,02 | 66,49 | 63,83 |
| EBB 210-40 F | 73,94 | 70,74 | 69,68 | 69,15 | 66,49 |
| EBB 210-50 F | 75,00 | 71,81 | 70,74 | 70,21 | 67,55 |
| EBB 210-60 F | 75,53 | 72,34 | 71,28 | 70,74 | 68,09 |
| EBB 210-75 F | 83,51 | 79,79 | 78,19 | 77,66 | 75,00 |
| EBB 210-100 F | 85,64 | 81,91 | 80,32 | 79,79 | 77,13 |

EBA & EBB 105

With a length of 105 mm for shorter labels

≡ Price per unit

| Art.no (L x H) | 1-24 ea. | 25-99 ea. | 100-249 ea. | 250-499 ea. | 500+ ea. |
|----------------|----------|-----------|-------------|-------------|----------|
| EBA 105-30 | 3,07 | 1,91 | 1,34 | 1,00 | 0,88 |
| EBA 105-40 | 3,09 | 1,94 | 1,36 | 1,01 | 0,89 |
| EBA 105-50 | 3,10 | 1,95 | 1,37 | 1,02 | 0,90 |
| EBA 105-60 | 3,11 | 1,96 | 1,38 | 1,03 | 0,91 |
| EBA 105-75 | 3,13 | 1,97 | 1,39 | 1,05 | 0,94 |
| EBA 105-100 | 3,16 | 2,00 | 1,43 | 1,09 | 0,97 |
| EBB 105-30 | 3,38 | 2,23 | 1,66 | 1,31 | 1,19 |
| EBB 105-40 | 3,39 | 2,24 | 1,67 | 1,33 | 1,21 |
| EBB 105-50 | 3,41 | 2,26 | 1,68 | 1,34 | 1,22 |
| EBB 105-60 | 3,41 | 2,27 | 1,69 | 1,35 | 1,23 |
| EBB 105-75 | 3,44 | 2,29 | 1,71 | 1,36 | 1,26 |
| EBB 105-100 | 3,46 | 2,31 | 1,73 | 1,39 | 1,28 |

EBB FR

With a stapled magnet, suitable for freezers

≡ Price per unit

| Art.no (L x H) | 1-24 ea. | 25-99 ea. | 100-249 ea. | 250-499 ea. | 500+ ea. |
|----------------|----------|-----------|-------------|-------------|----------|
| EBB 210-50 FR | 6,81 | 4,49 | 3,32 | 2,63 | 2,39 |
| EBB 210-60 FR | 6,82 | 4,50 | 3,33 | 2,64 | 2,40 |
| EBB 210-75 FR | 6,99 | 4,66 | 3,49 | 2,80 | 2,56 |

EBVA & EBVB

For marking on angled beam profiles



≡ 50 pcs/pack
 Δ Angle 27° or 45°
 ■ EBVA - Self-adhesive
 ■ EBVB - Magnetic

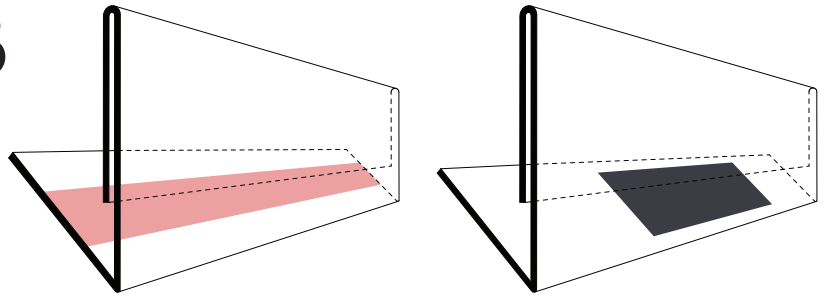

| Art.no (L x H) Angle 27° | Art.no (L x H) Angle 45° | 1-3 pack | 4-9 pack | 10-24 pack | 25-49 pack | 50+ pack |
|--------------------------|--------------------------|----------|----------|------------|------------|----------|
| EBVA 210-40 V27 F | EBVA 210-40 V45 F | 74,47 | 71,28 | 69,68 | 68,62 | 65,96 |
| EBVA 210-50 V27 F | EBVA 210-50 V45 F | 76,06 | 72,87 | 71,28 | 70,21 | 67,55 |
| EBVA 210-60 V27 F | EBVA 210-60 V45 F | 77,66 | 74,47 | 72,87 | 71,81 | 69,15 |
| EBVA 210-75 V27 F | EBVA 210-75 V45 F | 80,32 | 77,13 | 75,53 | 74,47 | 71,81 |
| EBVA 210-100 V27 F | EBVA 210-100 V45 F | 84,04 | 80,85 | 79,26 | 78,19 | 75,53 |
| EBVB 210-40 V27 F | EBVB 210-40 V45 F | 88,83 | 85,64 | 84,04 | 82,98 | 80,32 |
| EBVB 210-50 V27 F | EBVB 210-50 V45 F | 90,43 | 87,23 | 85,64 | 84,57 | 81,91 |
| EBVB 210-60 V27 F | EBVB 210-60 V45 F | 92,02 | 88,83 | 87,23 | 86,17 | 83,51 |
| EBVB 210-75 V27 F | EBVB 210-75 V45 F | 94,68 | 91,49 | 89,89 | 88,83 | 86,17 |
| EBVB 210-100 V27 F | EBVB 210-100 V45 F | 98,94 | 95,74 | 94,15 | 93,09 | 90,43 |

EBVA & EBVB 105

With a length of 105 mm for shorter labels

≡ Price per unit

| Art.no (L x H) Angle 27° | Art.no (L x H) Angle 45° | 1-24 ea. | 25-99 ea. | 100-249 ea. | 250-499 ea. | 500+ ea. |
|--------------------------|--------------------------|----------|-----------|-------------|-------------|----------|
| EBVA 105-40 V27 | EBVA 105-40 V45 | 7,73 | 4,31 | 2,61 | 1,57 | 1,23 |
| EBVA 105-50 V27 | EBVA 105-50 V45 | 7,76 | 4,33 | 2,62 | 1,60 | 1,24 |
| EBVA 105-60 V27 | EBVA 105-60 V45 | 7,77 | 4,34 | 2,64 | 1,61 | 1,27 |
| EBVA 105-75 V27 | EBVA 105-75 V45 | 7,80 | 4,37 | 2,66 | 1,64 | 1,29 |
| EBVA 105-100 V27 | EBVA 105-100 V45 | 7,84 | 4,41 | 2,70 | 1,68 | 1,34 |
| EBVB 105-40 V27 | EBVB 105-40 V45 | 5,98 | 3,65 | 2,49 | 1,79 | 1,55 |
| EBVB 105-50 V27 | EBVB 105-50 V45 | 6,00 | 3,67 | 2,50 | 1,81 | 1,57 |
| EBVB 105-60 V27 | EBVB 105-60 V45 | 6,01 | 3,68 | 2,52 | 1,82 | 1,59 |
| EBVB 105-75 V27 | EBVB 105-75 V45 | 6,04 | 3,71 | 2,54 | 1,85 | 1,62 |
| EBVB 105-100 V27 | EBVB 105-100 V45 | 6,09 | 3,76 | 2,60 | 1,89 | 1,66 |

EBVB FR

With a stapled magnet, suitable for freezers

≡ Price per unit

| Art.no (L x H) Angle 27° | Art.no (L x H) Angle 45° | 1-24 ea. | 25-99 ea. | 100-249 ea. | 250-499 ea. | 500+ ea. |
|--------------------------|--------------------------|----------|-----------|-------------|-------------|----------|
| EBVB 210-50 V27 FR | EBVB 210-50 V45 FR | 6,67 | 4,34 | 3,18 | 2,48 | 2,26 |
| EBVB 210-60 V27 FR | EBVB 210-60 V45 FR | 6,71 | 4,38 | 3,21 | 2,52 | 2,29 |
| EBVB 210-75 V27 FR | EBVB 210-75 V45 FR | 6,88 | 4,56 | 3,39 | 2,70 | 2,47 |

EX & EXB

Protective top for complete protection



≡ 50 pcs/pack
 EX - Self-adhesive
 EXB - Magnetic

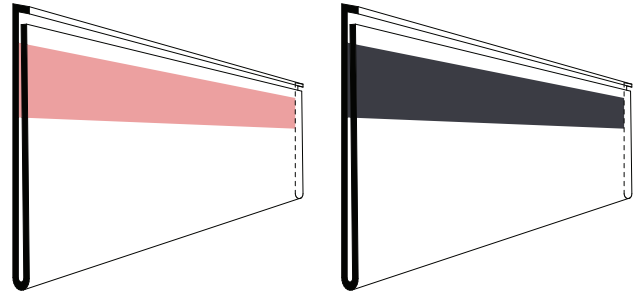

| Art.no (L x H) | 1-3 pack | 4-9 pack | 10-24 pack | 25-49 pack | 50+ pack |
|----------------|----------|----------|------------|------------|----------|
| EX 210-30 F | 23,94 | 20,74 | 19,68 | 18,62 | 18,09 |
| EX 210-39 F | 27,13 | 23,94 | 22,87 | 21,81 | 21,28 |
| EX 210-50 F | 30,32 | 27,13 | 26,06 | 25,00 | 24,47 |
| EX 210-60 F | 39,36 | 36,17 | 35,11 | 34,04 | 33,51 |
| EX 210-75 F | 53,72 | 50,53 | 49,47 | 48,40 | 47,87 |
| EX 210-100 F | 67,55 | 64,36 | 63,30 | 62,23 | 61,70 |
| EX 885-39 F | 89,36 | 86,17 | 85,11 | 84,04 | 83,51 |
| EX 885-50 F | 101,60 | 98,40 | 97,34 | 96,28 | 95,74 |
| EX 885-60 F | 139,89 | 136,70 | 135,64 | 134,57 | 134,04 |
| EX 1000-30 F | 85,11 | 81,91 | 80,85 | 79,79 | 78,19 |
| EX 1000-39 F | 97,87 | 94,68 | 93,62 | 92,55 | 90,96 |
| EX 1000-50 F | 110,11 | 106,91 | 105,85 | 104,79 | 103,19 |
| EX 1000-60 F | 152,13 | 148,94 | 147,87 | 146,81 | 145,21 |
| EX 1000-75 F | 227,66 | 224,47 | 223,40 | 222,34 | 220,74 |
| EX 1000-100 F | 293,09 | 289,89 | 288,83 | 287,77 | 286,17 |
| EXB 210-30 F | 48,40 | 45,21 | 44,15 | 43,09 | 42,55 |
| EXB 210-39 F | 53,19 | 50,00 | 48,94 | 47,87 | 47,34 |
| EXB 210-50 F | 56,91 | 53,72 | 52,66 | 51,60 | 51,06 |
| EXB 210-60 F | 69,68 | 66,49 | 65,43 | 64,36 | 63,83 |
| EXB 210-75 F | 81,38 | 78,19 | 77,13 | 76,06 | 75,53 |
| EXB 210-100 F | 97,87 | 94,68 | 93,62 | 92,55 | 92,02 |

EX & EXB 105

With a length of 105 mm for shorter labels

≡ Price per unit

| Art.no (L x H) | 1-24 ea. | 25-99 ea. | 100-249 ea. | 250-499 ea. | 500+ ea. |
|----------------|----------|-----------|-------------|-------------|----------|
| EX 105-30 | 3,18 | 1,72 | 0,99 | 0,55 | 0,40 |
| EX 105-39 | 3,21 | 1,74 | 1,02 | 0,57 | 0,44 |
| EX 105-50 | 3,23 | 1,78 | 1,04 | 0,61 | 0,46 |
| EX 105-60 | 3,33 | 1,86 | 1,13 | 0,69 | 0,54 |
| EX 105-75 | 3,48 | 2,02 | 1,29 | 0,85 | 0,70 |
| EX 105-100 | 3,62 | 2,16 | 1,43 | 0,99 | 0,84 |
| EXB 105-30 | 3,36 | 1,89 | 1,16 | 0,72 | 0,57 |
| EXB 105-39 | 3,40 | 1,94 | 1,20 | 0,77 | 0,62 |
| EXB 105-50 | 3,44 | 1,97 | 1,24 | 0,80 | 0,66 |
| EXB 105-60 | 3,53 | 2,07 | 1,34 | 0,90 | 0,76 |
| EXB 105-75 | 3,63 | 2,16 | 1,44 | 0,99 | 0,85 |
| EXB 105-100 | 3,76 | 2,30 | 1,56 | 1,13 | 0,98 |

EXV & EXVB

Protected marking for angled beam profiles



≡ 50 pcs/pack
 Δ Angle 27° or 45°
 ■ EXV - Self-adhesive
 ■ EXVB - Magnetic

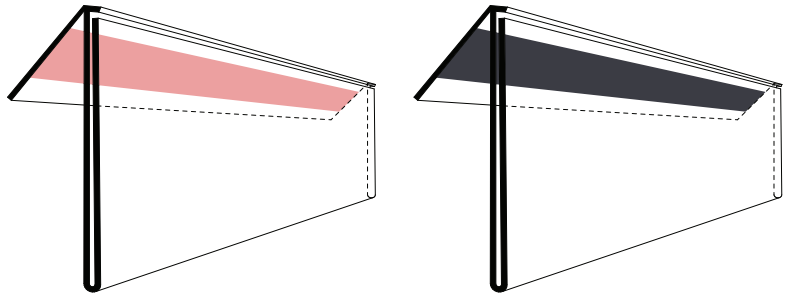

| Art.no (L x H) Angle 27° | Art.no (L x H) Angle 45° | 1-3 pack | 4-9 pack | 10-24 pack | 25-49 pack | 50+ pack |
|--------------------------|--------------------------|----------|----------|------------|------------|----------|
| EXV 210-39 V27 F | EXV 210-39 V45 F | 37,77 | 34,57 | 33,51 | 32,45 | 31,91 |
| EXV 210-50 V27 F | EXV 210-50 V45 F | 46,28 | 43,09 | 42,02 | 40,96 | 40,43 |
| EXV 210-60 V27 F | EXV 210-60 V45 F | 55,32 | 52,13 | 51,06 | 50,00 | 49,47 |
| EXVB 210-39 V27 F | EXVB 210-39 V45 F | 64,36 | 61,17 | 60,11 | 59,04 | 58,51 |
| EXVB 210-50 V27 F | EXVB 210-50 V45 F | 74,47 | 71,28 | 70,21 | 69,15 | 68,62 |
| EXVB 210-60 V27 F | EXVB 210-60 V45 F | 86,17 | 82,98 | 81,91 | 80,85 | 80,32 |

EXV & EXVB 105

With a length of 105 mm for shorter labels

≡ Price per unit

| Art.no (L x H) Angle 27° | Art.no (L x H) Angle 45° | 1-24 ea. | 25-99 ea. | 100-249 ea. | 250-499 ea. | 500+ ea. |
|--------------------------|--------------------------|----------|-----------|-------------|-------------|----------|
| EXV 105-39 V27 | EXV 105-39 V45 | 3,37 | 1,90 | 1,18 | 0,73 | 0,60 |
| EXV 105-50 V27 | EXV 105-50 V45 | 3,44 | 1,98 | 1,24 | 0,81 | 0,66 |
| EXV 105-60 V27 | EXV 105-60 V45 | 3,50 | 2,04 | 1,31 | 0,87 | 0,72 |
| EXVB 105-39 V27 | EXVB 105-39 V45 | 3,59 | 2,12 | 1,38 | 0,95 | 0,80 |
| EXVB 105-50 V27 | EXVB 105-50 V45 | 3,66 | 2,20 | 1,47 | 1,03 | 0,88 |
| EXVB 105-60 V27 | EXVB 105-60 V45 | 3,76 | 2,29 | 1,55 | 1,12 | 0,97 |

SBA & SBB

With open front for easy label change



≡ 50 pcs/pack
■ SBA - Self-adhesive
■ SBB - Magnetic

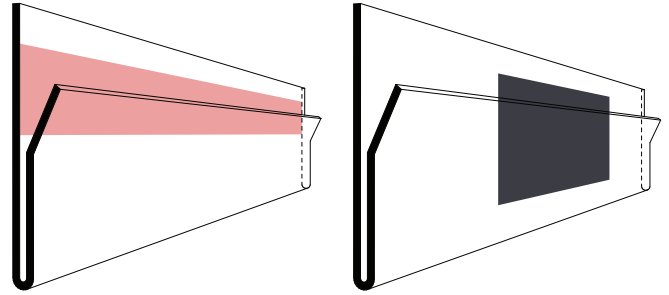

| Art.no (L x H) | 1-3 pack | 4-9 pack | 10-24 pack | 25-49 pack | 50+ pack |
|---------------------|----------|----------|------------|------------|----------|
| SBA 210-40 F | 64,89 | 61,70 | 60,64 | 60,11 | 57,98 |
| SBA 210-50 F | 65,85 | 62,66 | 61,60 | 61,06 | 58,94 |
| SBA 210-60 F | 68,09 | 64,89 | 63,83 | 63,30 | 61,17 |
| SBB 210-40 F | 86,70 | 83,51 | 82,45 | 81,91 | 79,79 |
| SBB 210-50 F | 88,30 | 85,11 | 84,04 | 83,51 | 81,38 |
| SBB 210-60 F | 90,43 | 87,23 | 86,17 | 85,64 | 83,51 |

SBA & SBB 105

With a length of 105 mm for shorter labels

≡ Price per unit

| Art.no (L x H) | 1-24 ea. | 25-99 ea. | 100-249 ea. | 250-499 ea. | 500+ ea. |
|-------------------|----------|-----------|-------------|-------------|----------|
| SBA 105-40 | 2,19 | 1,73 | 1,50 | 1,36 | 1,32 |
| SBA 105-50 | 2,20 | 1,74 | 1,51 | 1,37 | 1,33 |
| SBA 105-60 | 2,29 | 1,83 | 1,60 | 1,46 | 1,41 |
| SBB 105-40 | 2,56 | 2,11 | 1,87 | 1,73 | 1,69 |
| SBB 105-50 | 2,57 | 2,12 | 1,88 | 1,74 | 1,70 |
| SBB 105-60 | 2,66 | 2,20 | 1,97 | 1,83 | 1,79 |

EH & EHB

With open top for easy label mounting



≡ 50 pcs/pack
 EH - Self-adhesive
 EHB - Magnetic

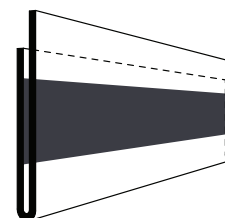
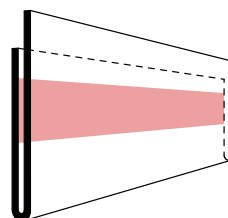

| Art.no (L x H) | 1-3 pack | 4-9 pack | 10-24 pack | 25-49 pack | 50+ pack |
|----------------|----------|----------|------------|------------|----------|
| EH 75-18 F | 20,96 | 17,77 | 16,70 | 16,17 | 15,64 |
| EH 100-18 F | 24,15 | 20,96 | 19,89 | 19,36 | 18,83 |
| EH 900-18 F | 108,94 | 104,68 | 102,55 | 100,96 | 100,43 |
| EH 950-18 F | 110,00 | 105,74 | 103,62 | 102,02 | 101,49 |
| EH 75-22 F | 20,32 | 17,13 | 16,06 | 15,53 | 15,00 |
| EH 100-22 F | 22,98 | 19,79 | 18,72 | 18,19 | 17,66 |
| EH 900-22 F | 100,74 | 96,49 | 94,36 | 92,77 | 92,23 |
| EH 950-22 F | 101,70 | 97,45 | 95,32 | 93,72 | 93,19 |
| EH 75-26 F | 20,11 | 16,91 | 15,85 | 15,32 | 14,79 |
| EH 100-26 F | 21,81 | 18,62 | 17,55 | 17,02 | 16,49 |
| EH 105-26 F | 21,81 | 18,62 | 17,55 | 17,02 | 16,49 |
| EH 900-26 F | 96,28 | 92,02 | 89,89 | 88,30 | 87,77 |
| EH 950-26 F | 97,66 | 93,40 | 91,28 | 89,68 | 89,15 |
| EH 1000-26 F | 99,47 | 95,21 | 93,09 | 91,49 | 90,96 |
| EH 1200-26 F | 101,06 | 96,81 | 94,68 | 93,09 | 92,55 |
| EHB 100-26 F | 49,79 | 46,60 | 45,53 | 45,00 | 44,47 |
| EHB 105-26 F | 50,11 | 46,91 | 45,85 | 45,32 | 44,79 |
| EHB 900-26 F | 208,51 | 204,26 | 202,13 | 200,53 | 199,47 |
| EHB 950-26 F | 212,02 | 207,77 | 205,64 | 204,04 | 202,98 |

EX & EXB

Protective top for complete protection



≡ 50 pcs/pack
 EX - Self-adhesive
 EXB - Magnetic

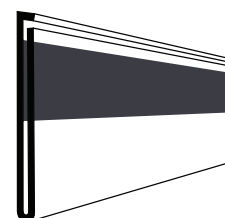
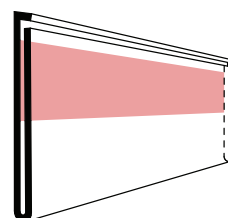

| Art.no (L x H) | 1-3 pack | 4-9 pack | 10-24 pack | 25-49 pack | 50+ pack |
|----------------|----------|----------|------------|------------|----------|
| EX 75-18 F | 17,66 | 14,47 | 13,40 | 12,87 | 12,34 |
| EX 100-18 F | 19,36 | 16,17 | 15,11 | 14,57 | 14,04 |
| EX 100-26 F | 17,77 | 14,57 | 13,51 | 12,98 | 12,45 |
| EX 105-26 F | 18,30 | 15,11 | 14,04 | 13,51 | 12,98 |
| EX 885-26 F | 66,06 | 61,81 | 59,68 | 58,09 | 57,02 |
| EX 900-26 F | 65,96 | 61,70 | 59,57 | 57,98 | 56,91 |
| EX 940-26 F | 69,15 | 64,89 | 62,77 | 61,17 | 60,11 |
| EX 950-26 F | 69,79 | 65,53 | 63,40 | 61,81 | 60,74 |
| EX 1000-18 F | 95,74 | 91,49 | 89,36 | 87,77 | 86,70 |
| EX 1000-26 F | 78,72 | 69,89 | 63,19 | 57,02 | 55,96 |
| EX 1200-26 F | 84,79 | 80,53 | 78,40 | 76,81 | 76,28 |
| EXB 75-18 F | 28,51 | 25,32 | 24,26 | 23,72 | 23,19 |
| EXB 100-18 F | 33,51 | 30,32 | 29,26 | 28,72 | 28,19 |
| EXB 100-26 F | 31,17 | 27,98 | 26,91 | 26,38 | 25,85 |
| EXB 105-26 F | 31,70 | 28,51 | 27,45 | 26,91 | 26,38 |

EXV & EX

Effective marking on angled shelf profiles (EXV)
Coloured background for ex. profiling (EX)

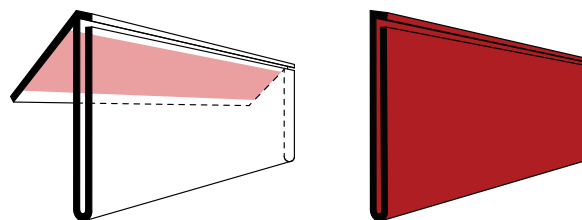

- ≡ 50 pcs/pack
- △ Angle 27° or 45° (only EXV)
- EXV - Self-adhesive
- EX - Self-adhesive, coloured background

| Art.no (L x H) | Angle | 1-3 pack | 4-9 pack | 10-24 pack | 25-49 pack | 50+ pack |
|-------------------|--------|----------|----------|------------|------------|----------|
| EXV 1000-26 V27 F | 27° | 117,13 | 112,87 | 110,74 | 109,15 | 108,09 |
| EXV 100-26 V45 F | 45° | 32,77 | 29,57 | 28,51 | 27,98 | 27,45 |
| EXV 105-26 V45 F | 45° | 33,40 | 30,21 | 29,15 | 28,62 | 28,09 |
| EXV 900-26 V45 F | 45° | 110,21 | 105,96 | 103,83 | 102,23 | 101,17 |
| EXV 940-26 V45 F | 45° | 114,47 | 110,21 | 108,09 | 106,49 | 105,43 |
| EXV 1000-26 V45 F | 45° | 117,13 | 112,87 | 110,74 | 109,15 | 108,09 |
| Art.no (L x H) | Colour | 1-3 pack | 4-9 pack | 10-24 pack | 25-49 pack | 50+ pack |
| EX 1000-26 B F | Blue | 92,66 | 88,40 | 86,28 | 84,68 | 83,62 |
| EX 1000-26 R F | Red | 92,66 | 88,40 | 86,28 | 84,68 | 83,62 |
| EX 1000-26 BL F | Black | 92,66 | 88,40 | 86,28 | 84,68 | 83,62 |
| EX 1000-26 W F | White | 92,66 | 88,40 | 86,28 | 84,68 | 83,62 |

EL & ELB

Moves the marking from the shelf profile

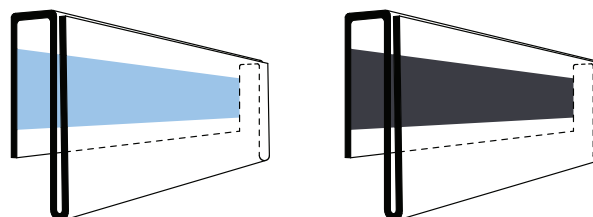

- ≡ 50 pcs/pack
- EL - Self-adhesive foam tape
- ELB - Magnetic

| Art.no (L x H) | 1-3 pack | 4-9 pack | 10-24 pack | 25-49 pack | 50+ pack |
|----------------|----------|----------|------------|------------|----------|
| EL 100-26 F | 37,34 | 34,15 | 33,09 | 32,55 | 31,49 |
| EL 105-26 F | 38,30 | 35,11 | 34,04 | 33,51 | 32,98 |
| EL 840-26 F | 114,15 | 109,89 | 107,77 | 106,17 | 105,11 |
| EL 940-26 F | 126,38 | 122,13 | 120,00 | 118,40 | 117,34 |
| EL 1230-26 F | 153,30 | 149,04 | 146,91 | 145,32 | 144,26 |
| EL 100-39 F | 43,51 | 40,32 | 39,26 | 38,72 | 37,66 |
| EL 105-39 F | 43,94 | 40,74 | 39,68 | 39,15 | 38,62 |
| EL 840-39 F | 156,28 | 152,02 | 149,89 | 148,30 | 147,23 |
| EL 940-39 F | 173,19 | 168,94 | 166,81 | 165,21 | 164,15 |
| EL 1230-39 F | 201,49 | 197,23 | 195,11 | 193,51 | 192,45 |
| ELB 100-26 F | 50,32 | 47,13 | 46,06 | 45,53 | 45,00 |
| ELB 105-26 F | 54,68 | 51,49 | 50,43 | 49,89 | 49,36 |
| ELB 840-26 F | 210,32 | 206,06 | 203,94 | 202,34 | 201,28 |
| ELB 940-26 F | 233,94 | 229,68 | 227,55 | 225,96 | 224,89 |
| ELB 1230-26 F | 281,28 | 277,02 | 274,89 | 273,30 | 272,23 |
| ELB 100-39 F | 57,98 | 54,79 | 53,72 | 53,19 | 52,66 |
| ELB 105-39 F | 59,47 | 56,28 | 55,21 | 54,68 | 54,15 |
| ELB 840-39 F | 214,57 | 210,32 | 208,19 | 206,60 | 205,53 |
| ELB 940-39 F | 238,30 | 234,04 | 231,91 | 230,32 | 229,26 |
| ELB 1230-39 F | 334,57 | 330,32 | 328,19 | 326,60 | 325,53 |

EHV & EHVB

Effective marking on angled shelf profiles



- ≡ 50 pcs/pack
- △ Angle 45°
- EHV - Self-adhesive foam tape
- EHVB - Magnetic

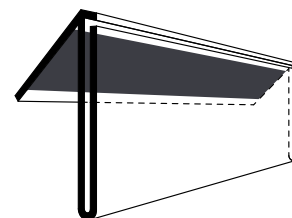
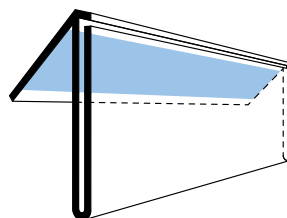

| Art.no (L x H) | 1-3 pack | 4-9 pack | 10-24 pack | 25-49 pack | 50+ pack |
|----------------|----------|----------|------------|------------|----------|
| EHV 100-26 F | 32,34 | 29,15 | 28,09 | 27,55 | 27,02 |
| EHV 105-26 F | 32,98 | 29,79 | 28,72 | 28,19 | 27,66 |
| EHV 840-26 F | 122,77 | 118,51 | 116,38 | 114,79 | 113,72 |
| EHV 940-26 F | 134,36 | 130,11 | 127,98 | 126,38 | 125,32 |
| EHV 1230-26 F | 156,91 | 152,66 | 150,53 | 148,94 | 147,87 |
| EHV 100-39 F | 34,89 | 31,70 | 30,64 | 30,11 | 29,57 |
| EHV 105-39 F | 35,96 | 32,77 | 31,70 | 31,17 | 30,64 |
| EHV 840-39 F | 134,68 | 130,43 | 128,30 | 126,70 | 125,64 |
| EHV 940-39 F | 147,98 | 143,72 | 141,60 | 140,00 | 138,94 |
| EHV 1230-39 F | 173,30 | 169,04 | 166,91 | 165,32 | 164,26 |
| EHVB 100-26 F | 40,85 | 37,66 | 36,60 | 36,06 | 35,53 |
| EHVB 105-26 F | 49,15 | 45,96 | 44,89 | 44,36 | 43,83 |
| EHVB 840-26 F | 137,13 | 132,87 | 130,74 | 129,15 | 128,09 |
| EHVB 940-26 F | 149,89 | 145,64 | 143,51 | 141,91 | 140,85 |
| EHVB 1230-26 F | 280,64 | 276,38 | 274,26 | 272,66 | 271,60 |
| EHVB 100-39 F | 42,45 | 39,26 | 38,19 | 37,66 | 37,13 |
| EHVB 105-39 F | 50,53 | 47,34 | 46,28 | 45,74 | 45,21 |
| EHVB 840-39 F | 149,57 | 145,32 | 143,19 | 141,60 | 140,53 |
| EHVB 940-39 F | 163,94 | 159,68 | 157,55 | 155,96 | 154,89 |
| EHVB 1230-39 F | 298,40 | 294,15 | 292,02 | 290,43 | 289,36 |

SPA & SPB

Holder for post with open front for easy and effective labeling



- ≡ 50 pcs/pack
- SPA - Self-adhesive
- SPB - Magnetic

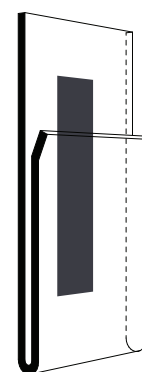
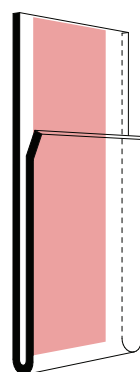

| Art.no (L x H) | 1-3 pack | 4-9 pack | 10-24 pack | 25-49 pack | 50+ pack |
|----------------|----------|----------|------------|------------|----------|
| SPA 75-150 F | 93,09 | 89,89 | 88,83 | 88,30 | 86,17 |
| SPB 75-150 F | 95,74 | 92,55 | 91,49 | 90,96 | 88,83 |

EF

Label holder with angled top and a thumb grip



- ≡ 50 pcs/pack
- △ For plastic crates
- Self-adhesive foam tape

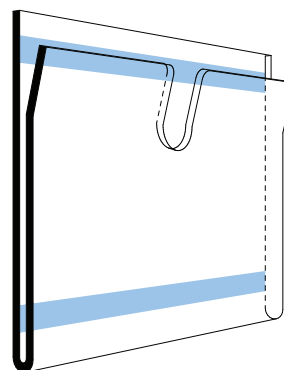

| Art.no (L x H) | 1-3 pack | 4-9 pack | 10-24 pack | 25-49 pack | 50+ pack |
|----------------|----------|----------|------------|------------|----------|
| EFA7 105-75 F | 93,08 | 89,89 | 88,82 | 88,29 | 85,63 |
| EFA6 150-105 F | 100,55 | 97,36 | 96,29 | 95,76 | 93,10 |
| EFA5 210-150 F | 124,48 | 121,28 | 120,22 | 119,69 | 117,03 |
| EFA4 300-210 F | 172,38 | 169,19 | 168,12 | 167,59 | 164,93 |

EHC

Open back for easy mounting of labels



- ≡ 50 pcs/pack
- △ For shelving
- Incl. 2 clips (unassembled)

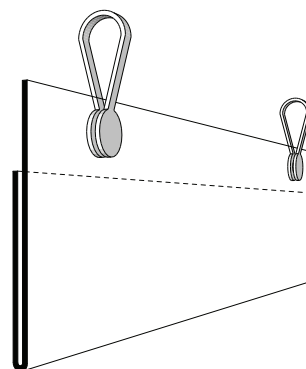

| Art.no (L x H) | 1-3 pack | 4-9 pack | 10-24 pack | 25-49 pack | 50+ pack |
|----------------|----------|----------|------------|------------|----------|
| EHC 105-26 F | 49,50 | 46,31 | 45,24 | 44,71 | 44,18 |
| EHC 210-30 F | 61,18 | 57,99 | 56,93 | 56,39 | 55,86 |
| EHC 210-40 F | 61,66 | 58,47 | 57,40 | 56,87 | 56,34 |
| EHC 210-50 F | 64,84 | 61,65 | 60,59 | 60,05 | 59,52 |
| EHC 210-60 F | 66,53 | 63,34 | 62,28 | 61,74 | 61,21 |
| EHC 210-75 F | 69,11 | 65,91 | 64,85 | 64,32 | 63,79 |
| EHC 210-100 F | 73,43 | 70,23 | 69,17 | 68,64 | 68,11 |

Divider

Divide your shelves and racking into section with a simple divider.
Available in adaptive, moveable and permanent solution.

AD

Adaptive divider kept in place by weight



≡ Price per unit

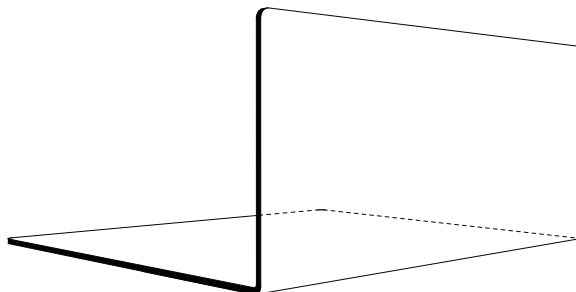

| Art.no (L x B x H) | 1-4 ea. | 5-9 ea. | 10-24 ea. | 25-49 ea. | 50+ ea. |
|------------------------|---------|---------|-----------|-----------|---------|
| AD 290-250-125 V90-4R | 9,57 | 6,91 | 5,64 | 4,79 | 4,26 |
| AD 490-250-125 V90-4R | 10,11 | 7,45 | 6,17 | 5,32 | 4,79 |
| AD 1050-250-125 V90-4R | 12,23 | 9,57 | 8,30 | 7,45 | 6,91 |

ADT

Permanent divider kept in place by tape



≡ Price per unit
■ Self-adhesive

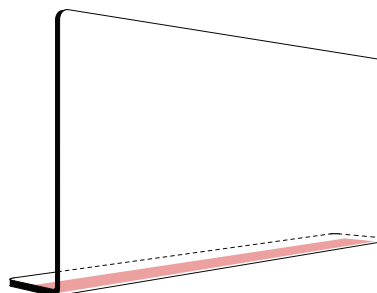

| Art.no (L x B x H) | 1-4 ea. | 5-9 ea. | 10-24 ea. | 25-49 ea. | 50+ ea. |
|------------------------|---------|---------|-----------|-----------|---------|
| ADT 290-35-125 V90-4R | 10,11 | 7,45 | 6,17 | 5,32 | 4,79 |
| ADT 490-35-125 V90-4R | 11,17 | 8,51 | 7,23 | 6,38 | 5,85 |
| ADT 1050-35-125 V90-4R | 12,77 | 10,11 | 8,83 | 7,98 | 7,45 |

ADB

Magnetic divider that is moveable



≡ Price per unit
■ Magnetic

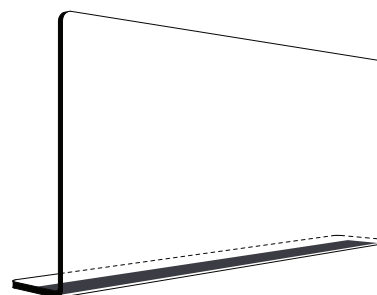

| Art.no (L x B x H) | 1-4 ea. | 5-9 ea. | 10-24 ea. | 25-49 ea. | 50+ ea. |
|------------------------|---------|---------|-----------|-----------|---------|
| ADB 290-35-125 V90-4R | 11,17 | 8,51 | 7,23 | 6,38 | 5,85 |
| ADB 490-35-125 V90-4R | 12,23 | 9,57 | 8,30 | 7,45 | 6,91 |
| ADB 1050-35-125 V90-4R | 14,89 | 12,23 | 10,96 | 10,11 | 9,57 |

Assorted complement

Sometimes it is difficult to find a good basis for attaching the label systems.
Examples of such surfaces are cantilevers, wire jaws, narrow surfaces, etc.

OK

OK consists of various products that help your holder to attach to difficult surfaces



≡ Price per unit
△ Bracket only, need to complete with a label holder

- OKG - Adapted to cantilevers
- OKH - Different types of hinges made of plastic
- OKT - Adapted to wire shelf/ceiling/wall
- OKS - Different suspension systems

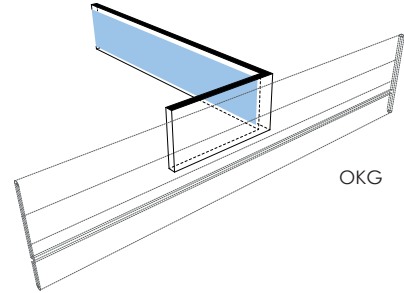

OKG

| Art.no (L x H) | Product | 1-4 ea. | 5-9 ea. | 10-24 ea. | 25-49 ea. | 50+ ea. |
|----------------|---|---------|---------|-----------|-----------|---------|
| OKG 30-60 V90 | Holder for cantilever with foam tape | 4,36 | 3,30 | 2,55 | 1,91 | 1,38 |
| OKG 60-60 V90 | Holder for cantilever with foam tape | 5,21 | 4,15 | 3,40 | 2,77 | 2,23 |
| OKH 150 | Plastic hinge 150 mm | 3,72 | 3,19 | 2,66 | 2,23 | 2,02 |
| OKH 210 | Plastic hinge 210 mm | 3,94 | 3,40 | 2,87 | 2,45 | 2,23 |
| OKS 50 | Hanging clips 50 mm, 100 units | 8,09 | 6,49 | 5,43 | 4,36 | 4,15 |
| OKS D19 | Binding ring 19 mm, 100 units | 24,47 | 22,87 | 21,81 | 20,74 | 19,68 |
| OKT 25-3 | Holder for wire/ceiling/wall with foam tape | 2,13 | 1,60 | 1,06 | 0,64 | 0,43 |



OKH

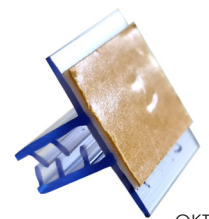

OKT



OKS D19

Psst!... want a good tip?

Did you know? - If you click on the article in our PDF offer / order / invoice, you will receive further information about the product on our website. This applies to all our standard products. Try it! It's good, right?



Kortsystem

ORDER CONFIRMATION

| | | |
|---------------------------|----------------------------|---------------------------|
| Order no 135330 | Customer no 1903 | Date 2024-06-19 |
|---------------------------|----------------------------|---------------------------|

Delivery adress
Humly Edtech AB
Von Utfallsgatan 1

415 05 Göteborg
Sverige

Delivery adress
Harrysson Ytbehandling AB
Åkarevögen 5
363 41 BRAÅS
Sverige

Our contact **Martina Davidsson**
Terms of delivery **EXW**
Way of transport **DHL Paket**
GAN no
Delivery date **2024-09-02**

Your contact **Pelle Harrysson**
Your order no **305187**
Order info
Goods marking

| Pos | Article ID/Specification | Quantity | Unit | Price | Amount |
|-----|---|----------|----------|--------|----------|
| 0 | EBVB 210-60 V45 F Label holder 210x60 mm, angled 45°, magnetic | 5 | /50 pack | 835,00 | 4 175,00 |
| 20 | EX 1000-26 B F Label holder 1000x26 mm, flat, tape, blue backside | 2 | /50 pack | 875,00 | 1 750,00 |
| 30 | FM25000-90Y Floor marking ribbon 25 m x 90 mm, yellow | 10 | St | 680,00 | 6 800,00 |
| 40 | IA3M300-420F Information holder 300x420 mm, flat, magnetic, portrait A3 | 1 | /10 pack | 520,00 | 520,00 |
| 50 | PF 700-500 D4 Plastic pocket 700x500 mm, 0.4 mm, mat, landscape, cc 500, 2 eyelet | 10 | St | 174,10 | 1 741,00 |

With delivery date Kortsystem refers to the date that we will ship your order.
This may vary by -5/+1 days without further notification.

Thank you for your order
Kind regards,

Martina Davidsson

Total SEK: 14 986,00
All prices are excluding VAT

Your VAT no:
Terms of payment: **20 days net**

Kortsystem i Gislaved AB
Box 277
SE-332 25 Gislaved
Sweden

Phone: +46(0)371-22 24 44
E-mail: info@kortsystem.se
Web: www.kortsystem.se
VAT no: SE556232928301

Bankgiro: 513-1636
SWIFT: SWEDSESS
IBAN SEK: SE4080000841789036081744
IBAN EUR: SE2280000841782376721862

Standard products with links have a blue color

Labels

We have a wide range for marking shelves and pallet racks with labels. Our labels use three types of material; cardboard paper, magnetic mat and self-adhesive vinyl.

With our own printer machines, we take responsibility for the entire production, so the label is delivered ready for installation.

Cardboard (KLP, KP, TE) is a strong paper label with a weight of 160 g / m².

We have both printed and unprinted cardboard paper labels. The printed one are delivered according to the customer's wishes, sorted and cut to the desired size and fits our label holders.

We can also deliver the cardboard label mounted in the selected holder, this facilitates the installation for your warehouse.

Unprinted labels comes in a perforated sheet that can be printed on a regular printer, then torn at the perforation to get the correct label size. Unprinted can be obtained as A3, A4 sheets or strips. Cardboard paper has no adhesive ability but is normally used together with our label holders.

Magnetic mat (GEM) consists of a permanently attached vinyl on a magnetic soft mat with a thickness of 1500 μ . The magnet is isotropic with a magnetic strength of 75 g/cm².

Our magnetic mat attaches perfectly to steel beams/pallet racks or shelves. An excellent choice if you want removable markings or labels that do not leave adhesive residues or other marks.

Our magnetic labels are printed in the same way as our vinyl labels (see below) and have the same type of durability and guarantees.

Vinyl labels is our biggest product of pre-printed labels. We have many vinyl labels types where the biggest difference between the types is the self-adhesive backing.

- GE - Our standard label, has permanent adhesive, durable and long life.
- GER - Label with semi-permanent adhesive, allowed to be removed or moved several times.
- GEF - Adhesive is freeze-resistant, can be installed in colder temperatures and withstand freezing.
- RME - The adhesive is for low energy surfaces, eg; fatty plastic, cardboard and wood.
- FM - Floor label is a printed GE with a laminated surface with a durable and anti-slip material.
- FMR - A removable floor marking, it is basically a GER laminated like FM.
- FMA - For asphalt, the adhesive is specially adapted and more sticky which works well on asphalt, it's also laminated.

Through a wide range of different colors, shapes, symbols and barcodes on the label, it is possible to get a uniform marking that suits your business optimally.

Advice for optimal installation results of vinyl labels;

- *Clean the surface with Surface Cleaner (see page 56) to counteract dirt and grease.*
- *The substrate must be dry and at least +10° C (does not apply to GEF which can handle -5° C).*
- *Press the entire adhesive surface against the substrate during installation.*
- *Permanent labels have a curing time of approx. 24 hours.*
- *It must be a smooth surface, eg; metal, glass or treated concrete (doesn't apply to RME).*
- *If the surface is porous/greasy/matte/textured, e.g.; wood, raw concrete, asphalt or fat plaster, we have special labels that fit those surfaces (see the list above).*

Kortsystem is a manufacturing company, we produce all our products in-house. If our standard product does not fit, you can always contact us directly and then we can help to produce a something that suits your needs. Examples of this are if you need a specific RAL/PMS/CMYK colour code as a background, a unique font or special dimensions/shape of the marking.

KLP

Perforated A4 sheet when you want to print the information yourself



- ≡ Price per sheet
- △ Perforated cardboard (160 g/m²)

Available in multiple colours (A4/A3-sheet).

■ Yellow ■ White

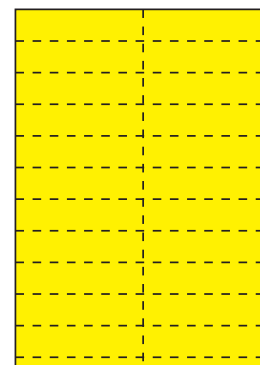
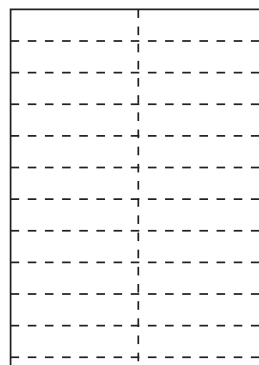

| Art.no (L x H) | Labels/sheet | Art.no (L x H) | Labels/sheet | Art.no (L x H) | Labels/sheet | Art.no (L x H) | Labels/sheet |
|----------------|--------------|----------------|--------------|----------------|--------------|----------------|--------------|
| KLP 105-18 # | 32 ea. | KLP 210-18 # | 18 ea. | KLP 300-40 # | 5 ea. | KLP 420-40 # | 7 ea. |
| KLP 105-22 # | 26 ea. | KLP 210-22 # | 13 ea. | KLP 300-50 # | 4 ea. | KLP 420-50 # | 6 ea. |
| KLP 105-26 # | 22 ea. | KLP 210-26 # | 11 ea. | KLP 300-60 # | 3 ea. | KLP 420-60 # | 5 ea. |
| KLP 105-30 # | 18 ea. | KLP 210-30 # | 9 ea. | KLP 300-75 # | 2 ea. | KLP 420-75 # | 4 ea. |
| KLP 105-40 # | 14 ea. | KLP 210-40 # | 7 ea. | KLP 300-100 # | 2 ea. | KLP 420-100 # | 3 ea. |
| KLP 105-50 # | 12 ea. | KLP 210-50 # | 6 ea. | | | | |
| KLP 105-60 # | 10 ea. | KLP 210-60 # | 5 ea. | | | | |
| KLP 105-75 # | 8 ea. | KLP 210-75 # | 4 ea. | | | | |

Price table applies to all art.no from above

| Sizes | 1-9 ea. | 10-49 ea. | 50-99 ea. | 100-199 ea. | 200+ ea. |
|---------------|---------|-----------|-----------|-------------|----------|
| 105, 210, 300 | 1,06 | 0,80 | 0,69 | 0,59 | 0,47 |
| 420 | 1,33 | 1,06 | 0,96 | 0,85 | 0,73 |

KP

Perforated unprinted sheets that are easy to divide



- ≡ Price per sheet
- △ Perforated cardboard (160 g/m²)

Available in multiple colours (A4/A3-sheet).

■ Yellow ■ White

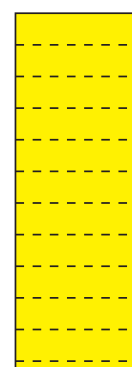
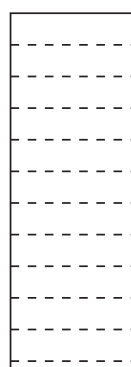

| Art.no (L x H) | Labels/sheet | Art.no (L x H) | Labels/sheet | Art.no (L x H) | Labels/sheet | Art.no (L x H) | Labels/sheet |
|----------------|--------------|----------------|--------------|----------------|--------------|----------------|--------------|
| KP 75-18 # | 16 ea. | KP 75-22 # | 13 ea. | KP 75-26 # | 11 ea. | KP 105-26 # | 11 ea. |
| KP 100-18 # | 16 ea. | KP 100-22 # | 13 ea. | KP 100-26 # | 11 ea. | | |

Price table applies to all art.no from above

| 1-9 ea. | 10-49 ea. | 50-99 ea. | 100-199 ea. | 200+ ea. |
|---------|-----------|-----------|-------------|----------|
| 0,98 | 0,74 | 0,64 | 0,53 | 0,44 |

TE

Printed labels that fits our label holders



- ≡ Price per unit
- △ Material is cardboard (160 g/m²)
- Available in multiple colours

KC-01 ↓ 

| Art.no (L x H) | Character limit | 1-24 ea. | 25-99 ea. | 100-249 ea. | 250-499 ea. | 500+ ea. |
|-------------------------------------|--------------------|----------|-----------|-------------|-------------|----------|
| TE 75-18 | 5-10 | 3,84 | 2,15 | 1,16 | 0,57 | 0,38 |
| TE 75-22 | 4-8 | 3,84 | 2,15 | 1,16 | 0,57 | 0,38 |
| TE 75-26 | 5-10 | 3,85 | 2,15 | 1,17 | 0,57 | 0,38 |
| TE 75-150 | 1 | 3,96 | 2,26 | 1,28 | 0,69 | 0,49 |
| TE 100-18 | 8-16 | 3,84 | 2,15 | 1,16 | 0,57 | 0,38 |
| TE 100-22 | 6-12 | 3,84 | 2,15 | 1,16 | 0,57 | 0,38 |
| TE 100-26 | 5-11 | 3,85 | 2,15 | 1,17 | 0,57 | 0,38 |
| TE 105-26 | 5-10 | 3,85 | 2,15 | 1,17 | 0,57 | 0,38 |
| TE 105-30 | 6-12 | 3,86 | 2,16 | 1,18 | 0,59 | 0,39 |
| TE 105-40 | 4-9 | 3,88 | 2,18 | 1,20 | 0,62 | 0,41 |
| TE 105-50 | 3-7 | 3,89 | 2,20 | 1,21 | 0,63 | 0,43 |
| TE 105-60 | 3-6 | 3,90 | 2,21 | 1,22 | 0,64 | 0,45 |
| TE 105-75 | 1-3 | 3,93 | 2,22 | 1,24 | 0,65 | 0,46 |
| TE 105-100 | 2-3 | 3,94 | 2,24 | 1,26 | 0,67 | 0,47 |
| TE 105-150 | 1-2 | 3,96 | 2,26 | 1,28 | 0,69 | 0,49 |
| TE 150-105 | 1-3 | 3,96 | 2,26 | 1,28 | 0,69 | 0,49 |
| TE 150-210 | 1-3 | 4,06 | 2,36 | 1,38 | 0,80 | 0,60 |
| TE 210-30 | 9-18 | 3,88 | 2,19 | 1,20 | 0,62 | 0,43 |
| TE 210-40 | 6-13 | 3,90 | 2,20 | 1,22 | 0,63 | 0,44 |
| TE 210-50 | 5-10 | 3,91 | 2,21 | 1,23 | 0,65 | 0,45 |
| TE 210-60 | 4-9 | 3,93 | 2,23 | 1,24 | 0,66 | 0,47 |
| TE 210-75 | 3-7 | 3,97 | 2,28 | 1,29 | 0,70 | 0,50 |
| TE 210-100 | 2-5 | 4,00 | 2,30 | 1,32 | 0,73 | 0,53 |
| TE 210-150 | 1-3 | 4,06 | 2,36 | 1,38 | 0,80 | 0,60 |
| TE 210-300 | 1 | 4,28 | 2,46 | 1,41 | 0,79 | 0,57 |
| TE 300-210 | 1-3 | 4,28 | 2,46 | 1,41 | 0,79 | 0,57 |
| Add-ons for cardboard labels | | | | | | |
| TE-P | Arrow | 0,27 | 0,19 | 0,15 | 0,07 | 0,04 |
| TE-ST 128 | Barcode 128 | 0,80 | 0,53 | 0,32 | 0,16 | 0,09 |
| TE-ST 39 | Barcode 39 | 0,80 | 0,53 | 0,32 | 0,16 | 0,09 |
| TE-ST QR | Barcode QR | 0,80 | 0,53 | 0,32 | 0,16 | 0,09 |
| TE-ST DM | Barcode DataMatrix | 0,80 | 0,53 | 0,32 | 0,16 | 0,09 |
| TE-C | Additional colour | 0,27 | 0,19 | 0,15 | 0,07 | 0,04 |
| MONT 02 | Assembling | 1,04 | 0,55 | 0,35 | 0,29 | 0,23 |



Printed labels on self-adhesive vinyl



≡ Price per unit

 Available in multiple colours

| Art.no (L x H) | Character height | Character limit | 1-24 ea. | 25-99 ea. | 100-249 ea. | 250-499 ea. | 500+ ea. |
|----------------------------------|--------------------|-----------------|-----------------|------------------|--------------------|--------------------|-----------------|
| GE 75-25 | 18 mm | 3-7 | 4,05 | 2,14 | 1,18 | 0,62 | 0,43 |
| GE 100-25 | 18 mm | 5-10 | 4,09 | 2,17 | 1,22 | 0,65 | 0,46 |
| GE 150-25 | 18 mm | 7-15 | 4,18 | 2,28 | 1,32 | 0,74 | 0,56 |
| GE 100-40 | 28 mm | 3-6 | 4,21 | 2,31 | 1,35 | 0,78 | 0,59 |
| GE 150-40 | 28 mm | 4-9 | 4,34 | 2,44 | 1,48 | 0,90 | 0,71 |
| GE 200-40 | 28 mm | 6-12 | 4,46 | 2,55 | 1,60 | 1,02 | 0,83 |
| GE 100-47 | 33 mm | 2-5 | 4,27 | 2,35 | 1,39 | 0,83 | 0,64 |
| GE 150-47 | 33 mm | 4-7 | 4,45 | 2,54 | 1,59 | 1,01 | 0,82 |
| GE 200-47 | 33 mm | 5-10 | 4,57 | 2,67 | 1,71 | 1,14 | 0,95 |
| GE 250-47 | 33 mm | 6-13 | 4,66 | 2,74 | 1,80 | 1,22 | 1,03 |
| GE 300-47 | 33 mm | 8-16 | 4,81 | 2,90 | 1,95 | 1,37 | 1,18 |
| GE 100-57 | 40 mm | 2-4 | 4,32 | 2,41 | 1,46 | 0,88 | 0,69 |
| GE 150-57 | 40 mm | 3-6 | 4,50 | 2,59 | 1,63 | 1,06 | 0,87 |
| GE 200-57 | 40 mm | 4-9 | 4,67 | 2,77 | 1,81 | 1,23 | 1,04 |
| GE 250-57 | 40 mm | 5-11 | 4,79 | 2,87 | 1,93 | 1,35 | 1,16 |
| GE 300-57 | 40 mm | 6-13 | 4,93 | 3,01 | 2,06 | 1,49 | 1,30 |
| GE 100-70 | 49 mm | 1-3 | 4,41 | 2,50 | 1,55 | 0,98 | 0,79 |
| GE 150-70 | 49 mm | 2-5 | 4,65 | 2,74 | 1,79 | 1,21 | 1,02 |
| GE 200-70 | 49 mm | 3-7 | 4,88 | 2,98 | 2,02 | 1,45 | 1,26 |
| GE 250-70 | 49 mm | 4-9 | 5,07 | 3,16 | 2,20 | 1,64 | 1,45 |
| GE 300-70 | 49 mm | 5-11 | 5,29 | 3,38 | 2,43 | 1,85 | 1,66 |
| Add-ons to printed labels | | | 1-24 ea. | 25-99 ea. | 100-249 ea. | 250-499 ea. | 500+ ea. |
| GE-P | Arrow | | 1,33 | 0,67 | 0,35 | 0,15 | 0,09 |
| GE-ST 128 | Barcode 128 | | 1,33 | 0,67 | 0,35 | 0,15 | 0,09 |
| GE-ST 39 | Barcode 39 | | 1,33 | 0,67 | 0,35 | 0,15 | 0,09 |
| GE-ST QR | Barcode QR | | 1,33 | 0,67 | 0,35 | 0,15 | 0,09 |
| GE-ST DM | Barcode DataMatrix | | 1,33 | 0,67 | 0,35 | 0,15 | 0,09 |
| GE-UT | Cut-out | | 1,33 | 0,67 | 0,35 | 0,15 | 0,09 |
| GE-C | Additional colour | | 2,16 | 1,17 | 0,67 | 0,38 | 0,28 |
| Art.no (L x H) | Character height | Character limit | 1-4 ea. | 5-9 ea. | 10-24 ea. | 25-49 ea. | 50+ ea. |
| GE 105-150 | 105 mm | 1 | 37,77 | 23,30 | 12,45 | 5,85 | 3,72 |
| GE 150-105 | 74 mm | 1-3 | 37,66 | 23,19 | 12,34 | 5,74 | 3,62 |
| GE 150-210 | 147 mm | 1 | 38,30 | 23,83 | 12,98 | 6,49 | 4,26 |
| GE 210-150 | 105 mm | 1-3 | 38,30 | 23,83 | 12,98 | 6,49 | 4,26 |
| GE 210-300 | 210 mm | 1 | 40,21 | 25,74 | 14,89 | 8,30 | 6,17 |
| GE 300-210 | 147 mm | 1-3 | 40,21 | 25,74 | 14,89 | 8,30 | 6,17 |
| GE 300-420 | 294 mm | 1 | 43,40 | 28,94 | 18,09 | 11,49 | 9,36 |
| GE 420-300 | 210 mm | 1-3 | 43,40 | 28,94 | 18,09 | 11,49 | 9,36 |
| GE 105-105 | 74 mm | 1-2 | 37,66 | 23,19 | 12,34 | 5,74 | 3,62 |
| GE 150-150 | 105 mm | 1-2 | 37,87 | 23,40 | 12,55 | 6,06 | 3,83 |
| GE 210-210 | 147 mm | 1-2 | 39,89 | 25,43 | 14,57 | 8,09 | 5,96 |
| GE 300-300 | 210 mm | 1-2 | 41,28 | 26,70 | 15,85 | 9,36 | 7,23 |



Serial printed labels on self-adhesive vinyl



≡ Price per sheet
 Available only with yellow background



| Art.no (L x H) | Char. height | Characters | Lbls/sheet | 1-9 ea. | 10-49 ea. | 50-99 ea. | 100-199 ea. | 200+ ea. |
|----------------|--------------|------------|------------|---------|-----------|-----------|-------------|----------|
| GSS 30-25 | 18 mm | 2 | 10 | 10,32 | 4,57 | 2,66 | 1,70 | 1,17 |
| GSS 45-25 | 18 mm | 3 | 10 | 10,43 | 4,79 | 2,87 | 1,91 | 1,38 |
| GSS 60-25 | 18 mm | 4 | 10 | 10,64 | 4,89 | 2,98 | 2,13 | 1,60 |
| GSS 50-47 | 35 mm | 2 | 6 | 10,53 | 4,79 | 2,87 | 1,91 | 1,49 |
| GSS 70-47 | 35 mm | 3 | 6 | 10,74 | 5,11 | 3,19 | 2,23 | 1,70 |
| GSS 90-47 | 35 mm | 4 | 6 | 10,96 | 5,32 | 3,40 | 2,45 | 1,91 |
| GSS 70-70 | 55 mm | 2 | 4 | 10,74 | 5,00 | 3,09 | 2,13 | 1,70 |
| GSS 100-70 | 55 mm | 3 | 4 | 11,06 | 5,32 | 3,40 | 2,45 | 2,02 |
| GSS 130-70 | 55 mm | 4 | 4 | 11,38 | 5,74 | 3,83 | 2,87 | 2,34 |

T

Pre-printed characters on self-adhesive vinyl



≡ Price per sheet
 Available only with yellow background



| Art.no | Length x Height | Characters/sheet | 1-9 ea. | 10-49 ea. | 50-99 ea. | 100-199 ea. | 200+ ea. |
|--------|-----------------|------------------|---------|-----------|-----------|-------------|----------|
| T 025 | 16 x 25 mm | 12 | 2,27 | 1,31 | 0,83 | 0,73 | 0,54 |
| T 050 | 28 x 50 mm | 6 | 2,41 | 1,46 | 0,98 | 0,88 | 0,70 |
| T 080 | 42 x 80 mm | 4 | 2,77 | 1,81 | 1,33 | 1,23 | 1,04 |
| T 150 | 75 x 150 mm | 1 | 2,60 | 1,64 | 1,17 | 1,07 | 0,88 |
| T 210 | 100 x 210 mm | 1 | 3,36 | 2,40 | 1,94 | 1,84 | 1,65 |
| T 300 | 210 x 300 mm | 1 | 5,64 | 4,54 | 4,00 | 3,89 | 3,68 |

GER

Printed labels on removeable self-adhesive vinyl

30B05  

- ≡ Price per unit
- △ Vinyl has air ducts that prevent air bubbles
- Available in multiple colours

| Art.no (L x H) | Character height | Character limit | 1-24 ea. | 25-99 ea. | 100-249 ea. | 250-499 ea. | 500+ ea. |
|----------------------------------|--------------------|-----------------|-----------------|------------------|--------------------|--------------------|-----------------|
| GER 75-25 | 18 mm | 3-7 | 4,14 | 2,23 | 1,28 | 0,70 | 0,51 |
| GER 100-25 | 18 mm | 5-10 | 4,24 | 2,33 | 1,38 | 0,81 | 0,62 |
| GER 150-25 | 18 mm | 7-15 | 4,43 | 2,52 | 1,56 | 0,99 | 0,80 |
| GER 100-40 | 28 mm | 3-6 | 4,46 | 2,55 | 1,60 | 1,02 | 0,84 |
| GER 150-40 | 28 mm | 4-9 | 4,69 | 2,78 | 1,82 | 1,26 | 1,06 |
| GER 200-40 | 28 mm | 6-12 | 4,91 | 3,00 | 2,05 | 1,48 | 1,29 |
| GER 100-47 | 33 mm | 2-5 | 4,54 | 2,63 | 1,68 | 1,11 | 0,91 |
| GER 150-47 | 33 mm | 4-7 | 4,89 | 2,99 | 2,03 | 1,46 | 1,27 |
| GER 200-47 | 33 mm | 5-10 | 5,10 | 3,18 | 2,22 | 1,66 | 1,47 |
| GER 250-47 | 33 mm | 6-13 | 5,29 | 3,38 | 2,43 | 1,85 | 1,66 |
| GER 300-47 | 33 mm | 8-16 | 5,59 | 3,67 | 2,71 | 2,15 | 1,96 |
| GER 100-57 | 40 mm | 2-4 | 4,64 | 2,73 | 1,78 | 1,20 | 1,02 |
| GER 150-57 | 40 mm | 3-6 | 4,96 | 3,04 | 2,10 | 1,52 | 1,33 |
| GER 200-57 | 40 mm | 4-9 | 5,27 | 3,36 | 2,40 | 1,83 | 1,64 |
| GER 250-57 | 40 mm | 5-11 | 5,51 | 3,60 | 2,65 | 2,07 | 1,88 |
| GER 300-57 | 40 mm | 6-13 | 5,78 | 3,86 | 2,91 | 2,34 | 2,15 |
| GER 100-70 | 49 mm | 1-3 | 4,81 | 2,90 | 1,95 | 1,37 | 1,18 |
| GER 150-70 | 49 mm | 2-5 | 5,26 | 3,34 | 2,39 | 1,82 | 1,63 |
| GER 200-70 | 49 mm | 3-7 | 5,77 | 3,86 | 2,90 | 2,33 | 2,14 |
| GER 250-70 | 49 mm | 4-9 | 6,11 | 4,20 | 3,24 | 2,67 | 2,48 |
| GER 300-70 | 49 mm | 5-11 | 6,53 | 4,63 | 3,67 | 3,10 | 2,90 |
| Add-ons to printed labels | | | 1-24 ea. | 25-99 ea. | 100-249 ea. | 250-499 ea. | 500+ ea. |
| GER-P | Arrow | | 1,33 | 0,67 | 0,35 | 0,15 | 0,09 |
| GER-ST 128 | Barcode 128 | | 1,33 | 0,67 | 0,35 | 0,15 | 0,09 |
| GER-ST 39 | Barcode 39 | | 1,33 | 0,67 | 0,35 | 0,15 | 0,09 |
| GER-ST QR | Barcode QR | | 1,33 | 0,67 | 0,35 | 0,15 | 0,09 |
| GER-ST DM | Barcode DataMatrix | | 1,33 | 0,67 | 0,35 | 0,15 | 0,09 |
| GER-UT | Cut-out | | 1,33 | 0,67 | 0,35 | 0,15 | 0,09 |
| GER-C | Additional colour | | 2,16 | 1,17 | 0,67 | 0,38 | 0,28 |

GEM

Printed labels on magnetic sheet



- ≡ Price per unit
- △ Resistant to water, oil and scratches
- Available in multiple colours

01-002-3



| Art.no (L x H) | Character height | Character limit | 1-24 ea. | 25-99 ea. | 100-249 ea. | 250-499 ea. | 500+ ea. |
|---|--------------------|-----------------|-----------------|------------------|--------------------|--------------------|-----------------|
| GEM 75-25 | 18 mm | 3-7 | 6,47 | 3,64 | 2,22 | 1,37 | 1,10 |
| GEM 100-25 | 18 mm | 5-10 | 6,70 | 3,87 | 2,46 | 1,61 | 1,32 |
| GEM 150-25 | 18 mm | 7-15 | 7,05 | 4,22 | 2,81 | 1,96 | 1,68 |
| GEM 100-40 | 28 mm | 3-6 | 7,15 | 4,32 | 2,90 | 2,06 | 1,78 |
| GEM 150-40 | 28 mm | 4-9 | 7,82 | 4,99 | 3,57 | 2,72 | 2,44 |
| GEM 200-40 | 28 mm | 6-12 | 8,18 | 5,35 | 3,94 | 3,09 | 2,80 |
| GEM 100-47 | 33 mm | 2-5 | 7,31 | 4,48 | 3,06 | 2,21 | 1,94 |
| GEM 150-47 | 33 mm | 4-7 | 7,99 | 5,16 | 3,74 | 2,89 | 2,61 |
| GEM 200-47 | 33 mm | 5-10 | 8,66 | 5,83 | 4,41 | 3,56 | 3,29 |
| GEM 250-47 | 33 mm | 6-13 | 9,31 | 6,48 | 5,06 | 4,21 | 3,93 |
| GEM 300-47 | 33 mm | 8-16 | 9,87 | 7,04 | 5,63 | 4,78 | 4,50 |
| GEM 100-57 | 40 mm | 2-4 | 7,54 | 4,71 | 3,30 | 2,45 | 2,17 |
| GEM 150-57 | 40 mm | 3-6 | 8,48 | 5,65 | 4,23 | 3,38 | 3,11 |
| GEM 200-57 | 40 mm | 4-9 | 9,31 | 6,48 | 5,06 | 4,21 | 3,94 |
| GEM 250-57 | 40 mm | 5-11 | 10,26 | 7,43 | 6,01 | 5,16 | 4,88 |
| GEM 300-57 | 40 mm | 6-13 | 10,99 | 8,16 | 6,74 | 5,89 | 5,61 |
| GEM 100-70 | 49 mm | 1-3 | 8,27 | 5,44 | 4,02 | 3,17 | 2,89 |
| GEM 150-70 | 49 mm | 2-5 | 8,86 | 6,03 | 4,62 | 3,77 | 3,48 |
| GEM 200-70 | 49 mm | 3-7 | 10,27 | 7,44 | 6,02 | 5,17 | 4,88 |
| GEM 250-70 | 49 mm | 4-9 | 11,27 | 8,44 | 7,02 | 6,17 | 5,89 |
| GEM 300-70 | 49 mm | 5-11 | 12,41 | 9,59 | 8,17 | 7,32 | 7,03 |
| Add-ons to printed magnetic labels | | | 1-24 ea. | 25-99 ea. | 100-249 ea. | 250-499 ea. | 500+ ea. |
| GEM-P | Arrow | | 1,33 | 0,67 | 0,35 | 0,15 | 0,09 |
| GEM-ST 128 | Barcode 128 | | 1,33 | 0,67 | 0,35 | 0,15 | 0,09 |
| GEM-ST 39 | Barcode 39 | | 1,33 | 0,67 | 0,35 | 0,15 | 0,09 |
| GEM-ST QR | Barcode QR | | 1,33 | 0,67 | 0,35 | 0,15 | 0,09 |
| GEM-ST DM | Barcode DataMatrix | | 1,33 | 0,67 | 0,35 | 0,15 | 0,09 |
| GEM-UT | Cut-out | | 1,36 | 0,70 | 0,37 | 0,17 | 0,11 |
| GEM-C | Additional colour | | 2,16 | 1,17 | 0,67 | 0,38 | 0,28 |

GEF

Printed labels on vinyl that is freezer resistant



- ≡ Price per unit
- △ Can be assembled on an active freezer (-5 degrees)
- Available in multiple colours

| Art.no (L x H) | Character height | Character limit | 1-24 ea. | 25-99 ea. | 100-249 ea. | 250-499 ea. | 500+ ea. |
|--|--------------------|-----------------|-----------------|------------------|--------------------|--------------------|-----------------|
| GEF 75-25 | 18 mm | 3-7 | 4,09 | 2,18 | 1,22 | 0,65 | 0,46 |
| GEF 100-25 | 18 mm | 5-10 | 4,13 | 2,22 | 1,27 | 0,69 | 0,50 |
| GEF 150-25 | 18 mm | 7-15 | 4,26 | 2,35 | 1,39 | 0,82 | 0,63 |
| GEF 100-40 | 28 mm | 3-6 | 4,29 | 2,37 | 1,43 | 0,85 | 0,66 |
| GEF 150-40 | 28 mm | 4-9 | 4,45 | 2,53 | 1,59 | 1,01 | 0,82 |
| GEF 200-40 | 28 mm | 6-12 | 4,60 | 2,68 | 1,73 | 1,16 | 0,97 |
| GEF 100-47 | 33 mm | 2-5 | 4,34 | 2,44 | 1,48 | 0,90 | 0,71 |
| GEF 150-47 | 33 mm | 4-7 | 4,56 | 2,66 | 1,70 | 1,13 | 0,95 |
| GEF 200-47 | 33 mm | 5-10 | 4,57 | 2,67 | 1,71 | 1,14 | 0,95 |
| GEF 250-47 | 33 mm | 6-13 | 4,85 | 2,94 | 1,98 | 1,41 | 1,22 |
| GEF 300-47 | 33 mm | 8-16 | 5,04 | 3,13 | 2,17 | 1,61 | 1,41 |
| GEF 100-57 | 40 mm | 2-4 | 4,41 | 2,50 | 1,55 | 0,98 | 0,79 |
| GEF 150-57 | 40 mm | 3-6 | 4,63 | 2,72 | 1,77 | 1,19 | 1,00 |
| GEF 200-57 | 40 mm | 4-9 | 4,85 | 2,95 | 1,99 | 1,41 | 1,22 |
| GEF 250-57 | 40 mm | 5-11 | 5,01 | 3,10 | 2,15 | 1,57 | 1,38 |
| GEF 300-57 | 40 mm | 6-13 | 5,19 | 3,29 | 2,33 | 1,76 | 1,56 |
| GEF 100-70 | 49 mm | 1-3 | 4,53 | 2,63 | 1,67 | 1,10 | 0,90 |
| GEF 150-70 | 49 mm | 2-5 | 4,82 | 2,91 | 1,96 | 1,38 | 1,19 |
| GEF 200-70 | 49 mm | 3-7 | 5,12 | 3,20 | 2,24 | 1,68 | 1,49 |
| GEF 250-70 | 49 mm | 4-9 | 5,35 | 3,45 | 2,49 | 1,91 | 1,72 |
| GEF 300-70 | 49 mm | 5-11 | 5,64 | 3,72 | 2,77 | 2,20 | 2,01 |
| Add-ons to printed freezer labels | | | 1-24 ea. | 25-99 ea. | 100-249 ea. | 250-499 ea. | 500+ ea. |
| GEF-P | Arrow | | 1,33 | 0,67 | 0,35 | 0,15 | 0,09 |
| GEF-ST 128 | Barcode 128 | | 1,33 | 0,67 | 0,35 | 0,15 | 0,09 |
| GEF-ST 39 | Barcode 39 | | 1,33 | 0,67 | 0,35 | 0,15 | 0,09 |
| GEF-ST QR | Barcode QR | | 1,33 | 0,67 | 0,35 | 0,15 | 0,09 |
| GEF-ST DM | Barcode DataMatrix | | 1,33 | 0,67 | 0,35 | 0,15 | 0,09 |
| GEF-UT | Cut-out | | 1,33 | 0,67 | 0,35 | 0,15 | 0,09 |
| GEF-C | Additional colour | | 2,16 | 1,17 | 0,67 | 0,38 | 0,28 |

RME

Printed labels on vinyl for low energy surfaces

C-33-03-1 ↑ 

≡ Price per unit

△ Low energy labels works with fatty plastic, cardboard, wood etc.

■ Available in multiple colours

| Art.no (L x H) | Character height | Character limit | 1-24 ea. | 25-99 ea. | 100-249 ea. | 250-499 ea. | 500+ ea. |
|---|--------------------|-----------------|-----------------|------------------|--------------------|--------------------|-----------------|
| RME 75-25 | 18 mm | 3-7 | 4,05 | 2,15 | 1,19 | 0,62 | 0,43 |
| RME 100-25 | 18 mm | 5-10 | 4,09 | 2,18 | 1,22 | 0,65 | 0,46 |
| RME 150-25 | 18 mm | 7-15 | 4,19 | 2,29 | 1,33 | 0,76 | 0,56 |
| RME 100-40 | 28 mm | 3-6 | 4,22 | 2,31 | 1,36 | 0,79 | 0,60 |
| RME 150-40 | 28 mm | 4-9 | 4,35 | 2,45 | 1,49 | 0,91 | 0,72 |
| RME 200-40 | 28 mm | 6-12 | 4,47 | 2,56 | 1,61 | 1,03 | 0,85 |
| RME 100-47 | 33 mm | 2-5 | 4,27 | 2,36 | 1,40 | 0,83 | 0,64 |
| RME 150-47 | 33 mm | 4-7 | 4,46 | 2,55 | 1,60 | 1,02 | 0,83 |
| RME 200-47 | 33 mm | 5-10 | 4,60 | 2,68 | 1,73 | 1,16 | 0,97 |
| RME 250-47 | 33 mm | 6-13 | 4,67 | 2,77 | 1,81 | 1,23 | 1,04 |
| RME 300-47 | 33 mm | 8-16 | 4,81 | 2,90 | 1,95 | 1,37 | 1,18 |
| RME 100-57 | 40 mm | 2-4 | 4,33 | 2,41 | 1,47 | 0,89 | 0,70 |
| RME 150-57 | 40 mm | 3-6 | 4,51 | 2,60 | 1,65 | 1,07 | 0,88 |
| RME 200-57 | 40 mm | 4-9 | 4,69 | 2,78 | 1,83 | 1,26 | 1,06 |
| RME 250-57 | 40 mm | 5-11 | 4,81 | 2,89 | 1,95 | 1,37 | 1,18 |
| RME 300-57 | 40 mm | 6-13 | 4,95 | 3,04 | 2,09 | 1,51 | 1,32 |
| RME 100-70 | 49 mm | 1-3 | 4,43 | 2,51 | 1,56 | 0,99 | 0,80 |
| RME 150-70 | 49 mm | 2-5 | 4,66 | 2,76 | 1,80 | 1,22 | 1,04 |
| RME 200-70 | 49 mm | 3-7 | 4,90 | 3,00 | 2,04 | 1,47 | 1,28 |
| RME 250-70 | 49 mm | 4-9 | 5,10 | 3,19 | 2,23 | 1,66 | 1,47 |
| RME 300-70 | 49 mm | 5-11 | 5,32 | 3,41 | 2,46 | 1,88 | 1,69 |
| Add-ons to printed low energy labels | | | 1-24 ea. | 25-99 ea. | 100-249 ea. | 250-499 ea. | 500+ ea. |
| RME-P | Arrow | | 1,33 | 0,67 | 0,35 | 0,15 | 0,09 |
| RME-ST 128 | Barcode 128 | | 1,33 | 0,67 | 0,35 | 0,15 | 0,09 |
| RME-ST 39 | Barcode 39 | | 1,33 | 0,67 | 0,35 | 0,15 | 0,09 |
| RME-ST QR | Barcode QR | | 1,33 | 0,67 | 0,35 | 0,15 | 0,09 |
| RME-ST DM | Barcode DataMatrix | | 1,33 | 0,67 | 0,35 | 0,15 | 0,09 |
| RME-UT | Cut-out | | 1,33 | 0,67 | 0,35 | 0,15 | 0,09 |
| RME-C | Additional colour | | 2,16 | 1,17 | 0,67 | 0,38 | 0,28 |

FM

Floor markings are used to create structure and order



- ≡ Price per unit
- △ Available in multiple shapes

Available in multiple colours (only single colours)

■ Yellow
 ■ White
 ■ Black
 ■ Red
 ■ Green
 ■ Blue

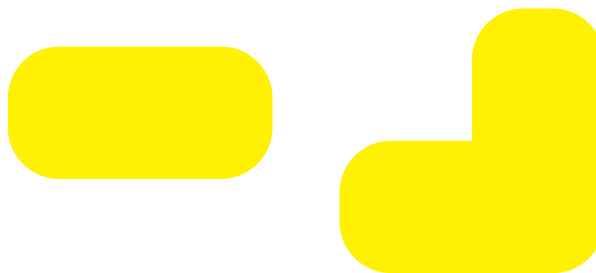

| Art.no | Length x Height | Shape | 1-24 ea. | 25-99 ea. | 100-249 ea. | 250-499 ea. | 500+ ea. |
|---------|-----------------|----------|----------|-----------|-------------|-------------|----------|
| FM 60 | 60 x 60 mm | Round | 3,74 | 2,07 | 1,24 | 0,74 | 0,57 |
| FM 60-1 | 120 x 60 mm | Elliptic | 3,93 | 2,26 | 1,43 | 0,93 | 0,76 |
| FM 60-2 | 120 x 120 mm | Corner | 4,32 | 2,65 | 1,81 | 1,31 | 1,15 |
| FM 60-3 | 180 x 120 mm | T-shape | 5,17 | 3,50 | 2,67 | 2,17 | 2,00 |
| FM 60-4 | 180 x 180 mm | Cross | 6,93 | 5,26 | 4,41 | 3,91 | 3,74 |
| FM 60-5 | 60 x 60 mm | Arrow | 3,74 | 2,07 | 1,24 | 0,74 | 0,57 |
| FM 90 | 90 x 90 mm | Round | 4,06 | 2,39 | 1,55 | 1,05 | 0,89 |
| FM 90-1 | 180 x 90 mm | Elliptic | 4,60 | 2,93 | 2,10 | 1,60 | 1,43 |
| FM 90-2 | 180 x 180 mm | Corner | 5,20 | 3,53 | 2,69 | 2,19 | 2,02 |
| FM 90-3 | 270 x 180 mm | T-shape | 6,95 | 5,28 | 4,44 | 3,94 | 3,77 |
| FM 90-4 | 270 x 270 mm | Cross | 9,24 | 7,57 | 6,73 | 6,23 | 6,06 |
| FM 90-5 | 90 x 90 mm | Arrow | 4,05 | 2,38 | 1,54 | 1,04 | 0,87 |
| FM 90-6 | 270 x 90 mm | Foot | 5,37 | 3,70 | 2,86 | 2,36 | 2,19 |

FMP

Floor markings that have a protected print



- ≡ Price per unit
- △ Available in multiple shapes
- Available in multiple colours



| Art.no | Length x Height | Shape | 1-4 ea. | 5-9 ea. | 10-24 ea. | 25-49 ea. | 50+ ea. |
|-------------|-----------------|--------------|---------|---------|-----------|-----------|---------|
| FMP 60 | 60 x 60 mm | Round | 46,81 | 20,43 | 9,89 | 6,28 | 3,51 |
| FMP 60-1 | 120 x 60 mm | Elliptic | 47,23 | 20,85 | 10,32 | 6,60 | 3,83 |
| FMP 60-2 | 120 x 120 mm | Corner | 47,77 | 21,49 | 10,96 | 7,23 | 4,47 |
| FMP 60-3 | 180 x 120 mm | T-shape | 49,26 | 22,98 | 12,45 | 8,72 | 5,96 |
| FMP 60-4 | 180 x 180 mm | Cross | 51,17 | 24,79 | 14,26 | 10,64 | 7,87 |
| FMP 60-5 | 60 x 60 mm | Arrow | 46,81 | 20,43 | 9,89 | 6,28 | 3,51 |
| FMP 90 | 90 x 90 mm | Round | 47,13 | 20,85 | 10,32 | 6,60 | 3,83 |
| FMP 90-1 | 180 x 90 mm | Elliptic | 47,98 | 21,60 | 11,06 | 7,34 | 4,57 |
| FMP 90-2 | 180 x 180 mm | Corner | 48,83 | 22,55 | 12,02 | 8,30 | 5,53 |
| FMP 90-3 | 270 x 180 mm | T-shape | 51,38 | 25,11 | 14,57 | 10,85 | 8,09 |
| FMP 90-4 | 270 x 270 mm | Cross | 54,36 | 27,98 | 17,45 | 13,83 | 11,06 |
| FMP 90-5 | 90 x 90 mm | Arrow | 47,13 | 20,85 | 10,32 | 6,60 | 3,83 |
| FMP 150-210 | 150 x 210 mm | A5 portrait | 49,57 | 23,19 | 12,66 | 8,94 | 6,17 |
| FMP 210-150 | 210 x 150 mm | A5 landscape | 49,47 | 23,19 | 12,66 | 8,94 | 6,17 |
| FMP 210-300 | 210 x 300 mm | A4 portrait | 52,34 | 25,96 | 15,43 | 11,70 | 8,94 |
| FMP 300-210 | 300 x 210 mm | A4 landscape | 52,34 | 25,96 | 15,43 | 11,70 | 8,94 |
| FMP 300-420 | 300 x 420 mm | A3 portrait | 57,66 | 31,38 | 20,85 | 17,13 | 14,36 |
| FMP 420-300 | 420 x 300 mm | A3 landscape | 57,45 | 31,06 | 20,53 | 16,91 | 14,15 |
| FMP 297 | 297 x 297 mm | Circle | 52,23 | 27,13 | 17,13 | 13,62 | 10,96 |

FMA

Floor markings with special adhesive and vinyl developed to be use on asphalt and concrete



- ≡ Price per unit
- △ Available in multiple shapes
- Available in multiple colours

| Art.no | Length x Height | Shape | 1-4 ea. | 5-9 ea. | 10-24 ea. | 25-49 ea. | 50+ ea. |
|-------------|-----------------|--------------|---------|---------|-----------|-----------|---------|
| FMA 60 | 60 x 60 mm | Round | 47,34 | 20,96 | 10,43 | 6,81 | 4,04 |
| FMA 60-1 | 120 x 60 mm | Elliptic | 47,98 | 21,70 | 11,17 | 7,45 | 4,68 |
| FMA 60-2 | 120 x 120 mm | Corner | 49,36 | 22,98 | 12,45 | 8,72 | 5,96 |
| FMA 60-3 | 180 x 120 mm | T-shape | 52,23 | 25,85 | 15,32 | 11,70 | 8,94 |
| FMA 60-4 | 180 x 180 mm | Cross | 55,96 | 29,68 | 19,15 | 15,43 | 12,66 |
| FMA 60-5 | 60 x 60 mm | Arrow | 47,23 | 20,85 | 10,32 | 6,70 | 3,94 |
| FMA 90 | 90 x 90 mm | Round | 48,09 | 21,70 | 11,17 | 7,55 | 4,79 |
| FMA 90-1 | 180 x 90 mm | Elliptic | 49,57 | 23,19 | 12,66 | 8,94 | 6,17 |
| FMA 90-2 | 180 x 180 mm | Corner | 51,38 | 25,11 | 14,57 | 10,85 | 8,09 |
| FMA 90-3 | 270 x 180 mm | T-shape | 56,60 | 30,32 | 19,79 | 16,06 | 13,30 |
| FMA 90-4 | 270 x 270 mm | Cross | 62,55 | 36,17 | 25,64 | 21,91 | 19,15 |
| FMA 90-5 | 90 x 90 mm | Arrow | 48,09 | 21,70 | 11,17 | 7,55 | 4,79 |
| FMA 150-210 | 150 x 210 mm | A5 portrait | 52,34 | 25,96 | 15,43 | 11,70 | 8,94 |
| FMA 210-150 | 210 x 150 mm | A5 landscape | 52,34 | 25,96 | 15,43 | 11,70 | 8,94 |
| FMA 210-300 | 210 x 300 mm | A4 portrait | 57,98 | 31,60 | 21,06 | 17,34 | 14,57 |
| FMA 300-210 | 300 x 210 mm | A4 landscape | 57,98 | 31,60 | 21,06 | 17,34 | 14,57 |
| FMA 300-420 | 300 x 420 mm | A3 portrait | 68,51 | 42,13 | 31,60 | 27,98 | 25,21 |
| FMA 420-300 | 420 x 300 mm | A3 landscape | 68,51 | 42,13 | 31,60 | 27,98 | 25,21 |
| FMA 297 | 297 x 297 mm | Circle | 59,57 | 34,57 | 24,47 | 20,96 | 18,40 |

FMS

A removable stencil that is self-adhesive on surfaces you want to paint. You simply remove after the paint has dried

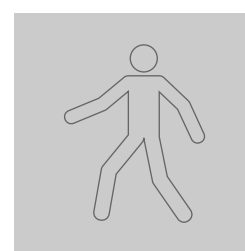

- ≡ Price per unit
- △ Available in multiple forms and symbols

| Art.no | Length x Height | Product | 1 ea. | 2 ea. | 3 ea. | 4 ea. | 5+ ea. |
|-----------|-----------------|------------------------|--------|-------|-------|-------|--------|
| FMS 360 W | 360 x 360 mm | Stencil symbol, white | 125,00 | 70,74 | 52,66 | 43,62 | 38,30 |
| FMS 360 Y | 360 x 360 mm | Stencil symbol, yellow | 125,00 | 70,74 | 52,66 | 43,62 | 38,30 |
| FMS 90 | 90 x 90 mm | Stencil round | 96,28 | 48,40 | 32,98 | 25,00 | 20,21 |
| FMS 90-1 | 180 x 90 mm | Stencil oval | 96,81 | 48,94 | 32,98 | 25,00 | 20,21 |
| FMS 90-2 | 180 x 180 mm | Stencil corner | 97,34 | 49,47 | 33,51 | 25,53 | 20,74 |
| FMS 90-3 | 270 x 180 mm | Stencil T-form | 98,94 | 51,06 | 35,11 | 27,13 | 22,34 |
| FMS 90-4 | 270 x 270 mm | Stencil cross | 101,06 | 53,19 | 37,23 | 29,26 | 24,47 |
| FMS 90-5 | 90 x 90 mm | Stencil arrow | 96,28 | 48,40 | 32,98 | 25,00 | 20,21 |
| FMS 90-6 | 270 x 90 mm | Stencil foot | 97,34 | 50,00 | 34,04 | 26,06 | 21,28 |

FMR

Floor markings that are removeable



- ≡ Price per unit
- △ Available in multiple shapes
- Available in multiple colours

| Art.no | Length x Height | Shape | 1-4 ea. | 5-9 ea. | 10-24 ea. | 25-49 ea. | 50+ ea. |
|-------------|-----------------|--------------|---------|---------|-----------|-----------|---------|
| FMR 60 | 60 x 60 mm | Round | 46,91 | 20,53 | 10,00 | 6,28 | 3,51 |
| FMR 60-1 | 120 x 60 mm | Elliptic | 47,34 | 20,96 | 10,43 | 6,81 | 4,04 |
| FMR 60-2 | 120 x 120 mm | Corner | 48,09 | 21,70 | 11,17 | 7,55 | 4,79 |
| FMR 60-3 | 180 x 120 mm | T-shape | 49,79 | 23,51 | 12,98 | 9,26 | 6,49 |
| FMR 60-4 | 180 x 180 mm | Cross | 52,23 | 25,85 | 15,32 | 11,70 | 8,94 |
| FMR 60-5 | 60 x 60 mm | Arrow | 46,91 | 20,53 | 10,00 | 6,28 | 3,51 |
| FMR 90 | 90 x 90 mm | Round | 47,34 | 21,06 | 10,43 | 6,81 | 4,04 |
| FMR 90-1 | 180 x 90 mm | Elliptic | 48,30 | 21,91 | 11,38 | 7,77 | 5,00 |
| FMR 90-2 | 180 x 180 mm | Corner | 49,36 | 23,09 | 12,55 | 8,83 | 6,06 |
| FMR 90-3 | 270 x 180 mm | T-shape | 52,45 | 26,17 | 15,64 | 11,91 | 9,15 |
| FMR 90-4 | 270 x 270 mm | Cross | 56,17 | 29,79 | 19,26 | 15,53 | 12,77 |
| FMR 90-5 | 90 x 90 mm | Arrow | 47,34 | 20,96 | 10,43 | 6,81 | 4,04 |
| FMR 150-210 | 150 x 210 mm | A5 portrait | 50,11 | 23,72 | 13,19 | 9,57 | 6,81 |
| FMR 210-150 | 210 x 150 mm | A5 landscape | 50,11 | 23,72 | 13,19 | 9,47 | 6,70 |
| FMR 210-300 | 210 x 300 mm | A4 portrait | 53,40 | 27,13 | 16,60 | 12,87 | 10,11 |
| FMR 300-210 | 300 x 210 mm | A4 landscape | 53,40 | 27,13 | 16,60 | 12,87 | 10,11 |
| FMR 300-420 | 300 x 420 mm | A3 portrait | 60,00 | 33,62 | 23,09 | 19,36 | 16,60 |
| FMR 420-300 | 420 x 300 mm | A3 landscape | 59,68 | 33,30 | 22,77 | 19,15 | 16,38 |
| FMR 297 | 297 x 297 mm | Circle | 53,83 | 28,72 | 18,72 | 15,21 | 12,55 |

Be inspired! Labels can be more functional

Unique designs for paper, vinyl, floors & signs.

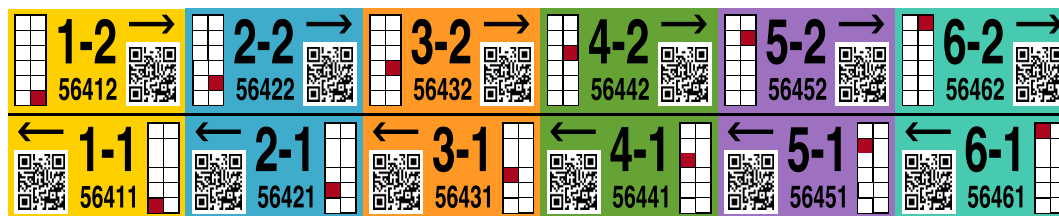



Kortsystem.se



FM rolls

Floor markings on rolls is used to define function areas e.g. truckways, production and installation sites



- ≡ Price per unit
- △ Self-adhesive laminated vinyl
- FM/FMP is for treated/painted floor
- FMA is for asphalt or floors with structure

Available in multiple colours

Yellow
 White
 Red
 Green
 Blue

Yellow/black stripes
 Red/white stripes

Luminous

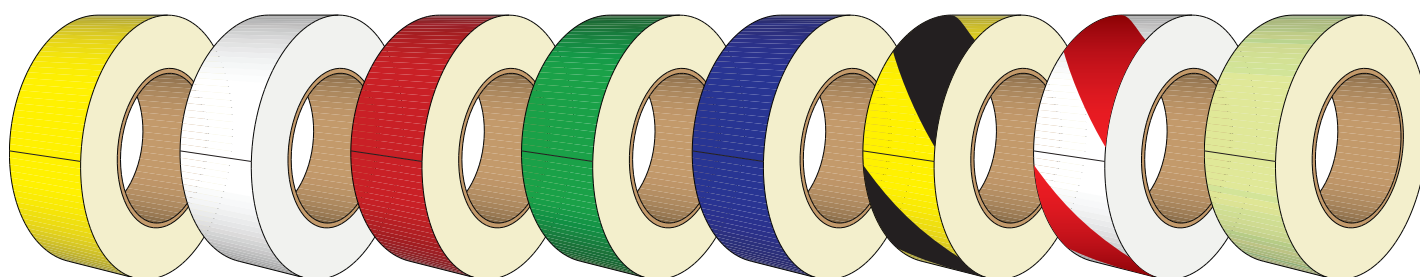

| Art.no (L x H) | Colour | 1-4 ea. | 5-9 ea. | 10-24 ea. | 25-49 ea. | 50+ ea. |
|------------------|-------------------|---------|---------|-----------|-----------|---------|
| FM 25000-60 | See colours above | 55,85 | 49,47 | 46,28 | 44,68 | 41,49 |
| FM 25000-90 | See colours above | 82,98 | 76,60 | 73,40 | 71,81 | 65,43 |
| FMP 24000-60 YBL | Yellow/Black | 136,91 | 130,53 | 127,34 | 125,74 | 123,62 |
| FMP 24000-60 WR | White/Red | 136,91 | 130,53 | 127,34 | 125,74 | 123,62 |
| FMP 24000-90 YBL | Yellow/Black | 210,85 | 204,47 | 201,28 | 199,68 | 197,55 |
| FMP 24000-90 WR | White/Red | 210,85 | 204,47 | 201,28 | 199,68 | 197,55 |
| FMA 24000-60 Y | Yellow | 190,32 | 183,94 | 180,74 | 179,15 | 177,02 |
| FMA 24000-60 YBL | Yellow/Black | 223,09 | 216,70 | 213,51 | 211,91 | 209,79 |
| FMA 24000-60 WR | White/Red | 223,09 | 216,70 | 213,51 | 211,91 | 209,79 |
| FMA 24000-90 Y | Yellow | 301,70 | 295,32 | 292,13 | 290,53 | 288,40 |
| FMA 24000-90 YBL | Yellow/Black | 354,79 | 348,40 | 345,21 | 343,62 | 341,49 |
| FMA 24000-90 WR | White/Red | 354,79 | 348,40 | 345,21 | 343,62 | 341,49 |
| FM 10000-88 L | Luminous | 195,96 | 189,57 | 186,38 | 184,79 | 182,13 |

MT - tape & band

Magnetic tape can be used to attach e.g. label holders.
Magnetic band have a vinyl that makes it possible to print or attach self-adhesive labels



- ≡ Price per unit
- △ Tape length is 50 meter, ribbon length is 20 meter

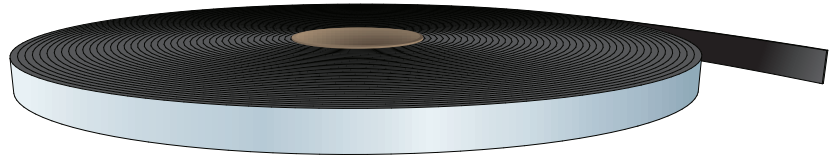

Available in multiple colours (ribbons)

■ Yellow
 ■ White
 ■ Red
 ■ Green
 ■ Blue



| Art.no (L x H) | Property | 1-4 ea. | 5-9 ea. | 10-24 ea. | 25-49 ea. | 50+ ea. |
|----------------|-------------------|---------|---------|-----------|-----------|---------|
| MT 50000-12 | Tape | 106,91 | 101,60 | 99,47 | 98,40 | 97,34 |
| MT 50000-19 | Tape | 145,21 | 139,89 | 137,77 | 136,70 | 135,64 |
| MT 50000-25 | Tape | 182,98 | 177,66 | 175,53 | 174,47 | 173,40 |
| Art.no (L x H) | Colour | 1-4 ea. | 5-9 ea. | 10-24 ea. | 25-49 ea. | 50+ ea. |
| MT 20000-25 | See colours above | 27,66 | 27,13 | 26,60 | 26,06 | 25,53 |
| MT 20000-50 | See colours above | 48,40 | 47,87 | 47,34 | 46,81 | 46,28 |

TEJP - tape

Warning tape in different colours



- ≡ Price per unit
- Available with yellow/black stripes
- Available with white/red stripes

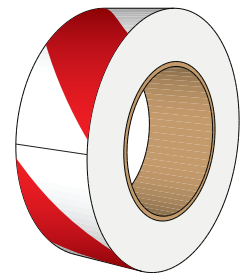
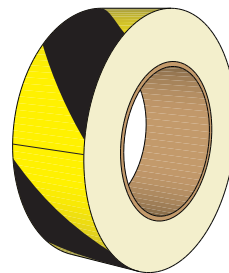

| Art.no (L x H) | Colour | 1-4 ea. | 5-9 ea. | 10-24 ea. | 25-49 ea. | 50+ ea. |
|-------------------|--------------|---------|---------|-----------|-----------|---------|
| TEJP 33000-50 YBL | Yellow/Black | 23,51 | 21,91 | 20,85 | 19,79 | 18,51 |
| TEJP 33000-50 WR | White/Red | 23,51 | 21,91 | 20,85 | 19,79 | 18,51 |

RM

Labels with special self-adhesive vinyl for low energy surfaces.



- ≡ Price per sheet
- △ Available in multiple symbols/colours
- Divided in multiple categories:
 - B - Fire protection
 - BG - Flammable gases
 - BV - Flammable liquids
 - FG - Corrosive and toxic
 - LV - Air and vacuum
 - V - Water
 - VA - Steam

All symbols and variants are available on our website and can be ordered at <https://www.kortsystem.se>

| Art.no (L x H) | Lbbs/sheet | 1-4 ea. | 5-9 ea. | 10-24 ea. | 25-49 ea. | 50+ ea. |
|----------------|------------|---------|---------|-----------|-----------|---------|
| RM 150-12 B | 20 | 34,15 | 15,96 | 8,72 | 6,17 | 4,26 |
| RM 150-12 BG | 20 | 34,15 | 15,96 | 8,72 | 6,17 | 4,26 |
| RM 150-12 BV | 20 | 34,15 | 15,96 | 8,72 | 6,17 | 4,26 |
| RM 150-12 FG | 20 | 34,15 | 15,96 | 8,72 | 6,17 | 4,26 |
| RM 150-12 LV | 20 | 34,15 | 15,96 | 8,72 | 6,17 | 4,26 |
| RM 150-12 V | 20 | 34,15 | 15,96 | 8,72 | 6,17 | 4,26 |
| RM 150-12 VA | 20 | 34,15 | 15,96 | 8,72 | 6,17 | 4,26 |
| RM 250-25 B | 10 | 35,74 | 17,55 | 10,32 | 7,77 | 5,85 |
| RM 250-25 BG | 10 | 35,74 | 17,55 | 10,32 | 7,77 | 5,85 |
| RM 250-25 BV | 10 | 35,74 | 17,55 | 10,32 | 7,77 | 5,85 |
| RM 250-25 FG | 10 | 35,74 | 17,55 | 10,32 | 7,77 | 5,85 |
| RM 250-25 LV | 10 | 35,74 | 17,55 | 10,32 | 7,77 | 5,85 |
| RM 250-25 V | 10 | 35,74 | 17,55 | 10,32 | 7,77 | 5,85 |
| RM 250-25 VA | 10 | 35,74 | 17,55 | 10,32 | 7,77 | 5,85 |
| RM 350-40 B | 7 | 37,34 | 19,15 | 11,91 | 9,36 | 7,45 |
| RM 350-40 BG | 7 | 37,34 | 19,15 | 11,91 | 9,36 | 7,45 |
| RM 350-40 BV | 7 | 37,34 | 19,15 | 11,91 | 9,36 | 7,45 |
| RM 350-40 FG | 7 | 37,34 | 19,15 | 11,91 | 9,36 | 7,45 |
| RM 350-40 LV | 7 | 37,34 | 19,15 | 11,91 | 9,36 | 7,45 |
| RM 350-40 V | 7 | 37,34 | 19,15 | 11,91 | 9,36 | 7,45 |
| RM 350-40 VA | 7 | 37,34 | 19,15 | 11,91 | 9,36 | 7,45 |
| RM 450-57 B | 5 | 38,94 | 20,74 | 13,51 | 10,96 | 9,04 |
| RM 450-57 BG | 5 | 38,94 | 20,74 | 13,51 | 10,96 | 9,04 |
| RM 450-57 BV | 5 | 38,94 | 20,74 | 13,51 | 10,96 | 9,04 |
| RM 450-57 FG | 5 | 38,94 | 20,74 | 13,51 | 10,96 | 9,04 |
| RM 450-57 LV | 5 | 38,94 | 20,74 | 13,51 | 10,96 | 9,04 |
| RM 450-57 V | 5 | 38,94 | 20,74 | 13,51 | 10,96 | 9,04 |
| RM 450-57 VA | 5 | 38,94 | 20,74 | 13,51 | 10,96 | 9,04 |

Information marking

Mandatory, Warning, Prohibition, Emergency, Fire hazard and Danger.



- ≡ Price per unit
- △ According to ISO-standard
- Available in different options:
VM - Self-adhesive vinyl
VMS - Hard plastic sign
VMA - Aluminum sign
VMF - Floor label



| Art.no (L x H) | Format | 1 ea. | 2 ea. | 3 ea. | 4 ea. | 5+ ea. |
|----------------|-------------|--------|-------|-------|-------|--------|
| VM 150-210 | A5 portrait | 18,62 | 12,02 | 9,79 | 8,72 | 8,09 |
| VM 210-300 | A4 portrait | 20,64 | 14,04 | 11,91 | 10,74 | 10,11 |
| VMS 150-210 | A5 portrait | 38,51 | 25,32 | 20,96 | 18,83 | 17,45 |
| VMS 210-300 | A4 portrait | 41,81 | 28,62 | 24,26 | 22,13 | 20,74 |
| VMA 150-210 | A5 portrait | 40,74 | 27,55 | 23,19 | 21,06 | 19,68 |
| VMA 210-300 | A4 portrait | 44,79 | 31,60 | 27,23 | 25,00 | 23,72 |
| VMF 150-210 | A5 portrait | 141,49 | 72,34 | 49,26 | 37,77 | 30,85 |
| VMF 210-300 | A4 portrait | 144,47 | 75,32 | 52,34 | 40,74 | 33,83 |

Available symbols can be found in our safety sign brochure or at Kortsystem website.

VML

Luminescent emergency markings



- ≡ Price per unit
- △ According to ISO-standard
- VML - Self-adhesive vinyl
VMLP - Hard plastic sign
VMLA - Aluminum sign



| Art.no (L x H) | Format | 1 ea. | 2 ea. | 3 ea. | 4 ea. | 5+ ea. |
|----------------|-------------|--------|--------|--------|-------|--------|
| VML 150-210 E | A5 portrait | 170,21 | 94,15 | 69,15 | 56,38 | 48,94 |
| VML 210-300 E | A4 portrait | 185,64 | 110,11 | 84,57 | 71,81 | 64,36 |
| VMLP 150-210 E | A5 portrait | 215,96 | 121,81 | 90,43 | 74,47 | 64,89 |
| VMLP 210-300 E | A4 portrait | 231,38 | 136,70 | 105,32 | 89,36 | 80,32 |
| VMLA 150-210 E | A5 portrait | 219,68 | 125,00 | 93,62 | 77,66 | 68,09 |
| VMLA 210-300 E | A4 portrait | 237,23 | 142,55 | 111,17 | 95,21 | 86,06 |

PM

Placement decals for order



- ≡ Price per unit
- △ Available in multiple symbols
 - PM - Self-adhesive vinyl
 - PMP - Hard plastic sign
 - PMA - Aluminum sign
 - PMF - Floor marking



| Art.no (L x H) | Format | 1 ea. | 2 ea. | 3 ea. | 4 ea. | 5+ ea. |
|----------------|-------------|--------|-------|-------|-------|--------|
| PM 150-210 | A5 portrait | 18,62 | 12,02 | 9,79 | 8,72 | 8,09 |
| PM 210-300 | A4 portrait | 20,74 | 14,04 | 11,91 | 10,64 | 10,11 |
| PMP 150-210 | A5 portrait | 141,49 | 73,62 | 51,06 | 39,89 | 32,98 |
| PMP 210-300 | A4 portrait | 144,68 | 76,91 | 54,26 | 43,19 | 36,38 |
| PMA 150-210 | A5 portrait | 171,28 | 90,96 | 63,83 | 50,53 | 42,55 |
| PMA 210-300 | A4 portrait | 176,06 | 95,21 | 68,62 | 54,79 | 46,81 |
| PMF 150-210 | A5 portrait | 141,49 | 72,34 | 49,26 | 37,77 | 30,85 |
| PMF 210-300 | A4 portrait | 144,68 | 75,53 | 52,66 | 40,96 | 34,04 |

RC

Recycle decals for the environment



- ≡ Price per unit
- △ Available in multiple symbols
 - RC - Self-adhesive vinyl
 - RCP - Hard plastic sign
 - RCA - Aluminum sign
 - RCF - Floor marking



| Art.no (L x H) | Format | 1 ea. | 2 ea. | 3 ea. | 4 ea. | 5+ ea. |
|----------------|-------------|--------|-------|-------|-------|--------|
| RC 150-210 | A5 portrait | 18,62 | 12,02 | 9,79 | 8,72 | 8,09 |
| RC 210-300 | A4 portrait | 20,74 | 14,04 | 11,91 | 10,64 | 10,11 |
| RCP 150-210 | A5 portrait | 141,06 | 73,94 | 51,06 | 39,89 | 32,98 |
| RCP 210-300 | A4 portrait | 144,68 | 77,13 | 54,26 | 43,19 | 36,38 |
| RCA 150-210 | A5 portrait | 171,81 | 90,74 | 63,83 | 50,53 | 42,55 |
| RCA 210-300 | A4 portrait | 176,06 | 95,21 | 68,09 | 54,79 | 46,81 |
| RCF 150-210 | A5 portrait | 141,49 | 72,34 | 49,26 | 37,77 | 30,85 |
| RCF 210-300 | A4 portrait | 144,68 | 75,53 | 52,34 | 40,74 | 34,04 |

Get a sample

A real sample of our product gives you the opportunity to feel the **quality**, test its **functionality** and see our **design** work in practice.

Order one (or more) samples directly from our website - free of charge!



EBVB 210-50 V27 FR

Label holder 210x50 mm, angled 27°, stapled magnetic, freezer

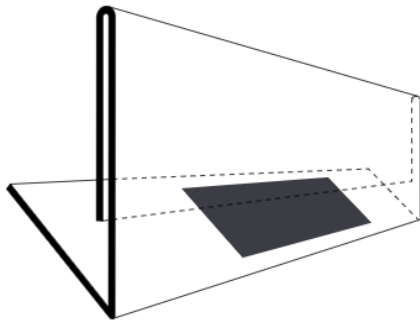

Product description:

EBVB-holder is well suited for angled beam profiles or for making it easier to read labels at higher or lower heights.
Notice! The dimensions describes the label size that fits the holder and not the size of the holder.

Modify your product

1. Choose angle

27 deg. 45 deg.

2. Choose size (L x H)

210-50 210-60 210-75



* Click for bigger size *

Price for EBVB 210-50 V27 FR

Total value: **6,51** (EUR)

Amount of each:

Quantity discount (for each)

| Quantity | Price per unit (EUR) |
|-------------|----------------------|
| 1-24 ea. | 6,51 |
| 25-99 ea. | 4,26 |
| 100-249 ea. | 3,13 |
| 250-499 ea. | 2,46 |
| 500+ ea. | 2,23 |

How do I order a sample?

Very simple!

- Step 1 - Go to our website: <https://www.kortsystem.se>
- Step 2 - Go to the page where the product is located
- Step 3 - Select product, click the green button "Get a sample"

Done!

Signs

Kortsystem manufactures a wide range of signs. We have a good experience of how large the signs and their information should be for good readability at a given distance.

The traditional sign is a printed vinyl permanently mounted on a transparent sheet of plastic. As standard, the sign has a flap with self-adhesive tape. Single-sided or double-sided.

With this as a starting point, there are several customizations and features to get the perfect sign. You can get it;

- with hard plastic or aluminum for better durability/outdoors (GEP, GEA)
- with a 90° angle, the sign sticks out in the aisle for better visibility (add-on GES V-90)
- with holes in each corner - to be screwed to the wall or hung (included with GEP, GEA)
- with self-adhesive foam tape for uneven surfaces (add-on GES-F)
- with magnets for easier movement/exchange (add-on GES-M)
- with angle 45° and angled list VL you can create a plow sign (2 pcs GES, VL and add-on V45)
- unprinted flat or angled signs to attach own label (SK, GS)
- without print. Order separate marking for your own installation (T-sign, GE)
- as a holder where you can insert your own cardboard label in A-format (GBA/GBB)
- as a post/rack sign or as a printed angled holder for pallet racking (GES-Stolpe, TVA)
- as a large four-sided sign to hang from the warehouse ceiling (GET)

If you cannot find your sign solution, contact us and we will help you.

The lifespan of our signs outdoors where it is exposed to sun, wind and rain is 5 to 7 years.

In an indoor warehouse, the lifespan of a printed sign is a very long time - so long that we don't know the answer.

GES

Assembled aisle signs with long durability



- ≡ Price per unit
- △ Single or double sided assembly
- Self-adhesive
- Available in multiple colours

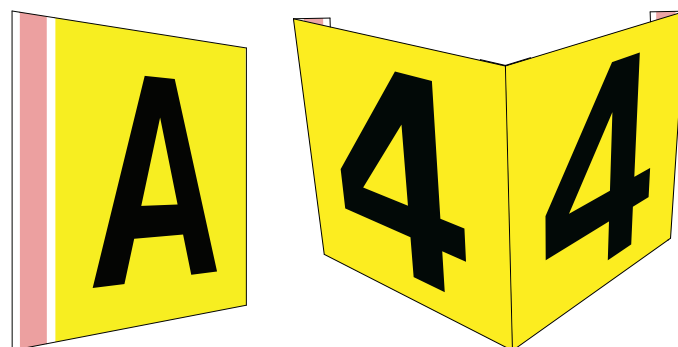

Standard for all aisle signs is straight, left-hung and with self-adhesive tape. For angled or magnetic is add-ons. For the right-hung one, it must be in spec.

Single-sided (-1) have adhesive on the back

| Art.no (L x H) | Art.no (L x H) | 1-4 ea. | 5-9 ea. | 10-24 ea. | 25-49 ea. | 50+ ea. |
|--|----------------|----------------|----------------|------------------|------------------|----------------|
| GES 105-150-1 | GES 150-105-1 | 50,38 | 28,00 | 16,44 | 10,81 | 8,21 |
| GES 150-210-1 | GES 210-150-1 | 51,37 | 28,99 | 17,86 | 12,01 | 9,10 |
| GES 210-300-1 | GES 300-210-1 | 54,23 | 32,06 | 20,82 | 15,09 | 12,49 |
| GES 300-420-1 | GES 420-300-1 | 60,90 | 38,43 | 27,50 | 21,22 | 18,64 |
| GES 105-105-1 | | 50,18 | 27,70 | 16,46 | 10,61 | 7,90 |
| GES 150-150-1 | | 50,41 | 27,93 | 16,68 | 10,84 | 8,14 |
| GES 210-210-1 | | 52,76 | 30,27 | 19,02 | 13,18 | 10,48 |
| GES 300-300-1 | | 56,11 | 33,62 | 22,38 | 16,53 | 13,83 |
| Double-sided assembly | | | | | | |
| GES 105-150-2 | GES 150-105-2 | 53,51 | 31,02 | 19,79 | 13,94 | 11,23 |
| GES 150-210-2 | GES 210-150-2 | 54,82 | 32,45 | 20,99 | 15,46 | 12,77 |
| GES 210-300-2 | GES 300-210-2 | 61,45 | 38,53 | 27,50 | 21,77 | 18,64 |
| GES 300-420-2 | GES 420-300-2 | 71,88 | 48,97 | 37,95 | 32,31 | 29,07 |
| GES 105-105-2 | | 53,33 | 30,84 | 19,60 | 13,76 | 11,05 |
| GES 150-150-2 | | 53,79 | 31,30 | 20,05 | 14,21 | 11,51 |
| GES 210-210-2 | | 58,19 | 35,71 | 24,47 | 18,62 | 15,93 |
| GES 300-300-2 | | 64,36 | 41,87 | 30,63 | 24,79 | 22,09 |
| Add-ons to signs | | 1-4 ea. | 5-9 ea. | 10-24 ea. | 25-49 ea. | 50+ ea. |
| GES-V 45 | Angle 45° | 8,38 | 6,05 | 3,82 | 2,11 | 1,32 |
| GES-V 90 | Angle 90° | 8,38 | 6,05 | 3,82 | 2,11 | 1,32 |
| GES-M | Magnetic tape | 3,90 | 2,46 | 1,36 | 0,79 | 0,53 |
| GES-F | Foam tape | 3,90 | 2,46 | 1,36 | 0,79 | 0,53 |
| Angled list 90° with self-adhesive to plowsigns | | 1-4 ea. | 5-9 ea. | 10-24 ea. | 25-49 ea. | 50+ ea. |
| VL 105 | 105x25x25 mm | 5,37 | 4,95 | 4,73 | 4,63 | 4,31 |
| VL 150 | 150x25x25 mm | 5,41 | 4,99 | 4,78 | 4,67 | 4,35 |
| VL 210 | 210x25x25 mm | 5,54 | 5,12 | 4,90 | 4,80 | 4,48 |
| VL 300 | 300x25x25 mm | 5,61 | 5,18 | 4,97 | 4,86 | 4,54 |
| VL 420 | 420x25x25 mm | 5,77 | 5,34 | 5,13 | 5,02 | 4,70 |

GES Rack Signs

Assembled signs for rack uprights or poles



- ≡ Price per unit
- △ With foam-tape for uneven surfaces



| Art.no (L x H) | 1-4 ea. | 5-9 ea. | 10-24 ea. | 25-49 ea. | 50+ ea. |
|-----------------|---------|---------|-----------|-----------|---------|
| GES 80-150-1 SK | 46,48 | 26,19 | 16,04 | 10,77 | 8,33 |
| GES 80-200-1 SK | 47,07 | 26,78 | 16,88 | 11,35 | 8,93 |
| GES 80-250-1 SK | 47,32 | 27,02 | 16,87 | 11,60 | 9,16 |
| GES 80-300-1 SK | 52,16 | 29,67 | 18,43 | 12,59 | 9,88 |
| GES 90-150-1 SK | 46,60 | 26,30 | 16,16 | 10,88 | 8,45 |
| GES 90-200-1 SK | 47,06 | 26,78 | 16,63 | 11,35 | 8,91 |
| GES 90-250-1 SK | 51,85 | 29,37 | 18,13 | 12,28 | 9,59 |
| GES 90-300-1 SK | 52,61 | 30,13 | 18,88 | 13,03 | 10,33 |

GEP

Assembled aisle signs on hard plastic



- ≡ Price per unit
- △ Available in single or double sided assembly
- Incl. 4 holes in each corner for assembly
- Available in multiple colours



| Art.no (L x H) | Art.no (L x H) | 1-4 ea. | 5-9 ea. | 10-24 ea. | 25-49 ea. | 50+ ea. |
|-------------------------------------|------------------|----------------|----------------|------------------|------------------|----------------|
| GEP 105-150-1 | GEP 150-105-1 | 60,39 | 33,52 | 19,77 | 13,20 | 9,87 |
| GEP 150-210-1 | GEP 210-150-1 | 61,40 | 34,53 | 21,20 | 14,22 | 10,99 |
| GEP 210-300-1 | GEP 300-210-1 | 65,33 | 38,46 | 25,23 | 18,14 | 14,81 |
| GEP 300-420-1 | GEP 420-300-1 | 71,29 | 44,95 | 31,19 | 24,10 | 20,77 |
| GEP 105-105-1 | | 60,16 | 33,29 | 19,85 | 12,86 | 9,64 |
| GEP 150-150-1 | | 60,73 | 33,86 | 20,43 | 13,44 | 10,21 |
| GEP 210-210-1 | | 63,46 | 36,59 | 23,15 | 16,17 | 12,94 |
| GEP 300-300-1 | | 67,86 | 40,99 | 27,55 | 20,56 | 17,34 |
| Double-sided assembly | | | | | | |
| GEP 105-150-2 | GEP 150-105-2 | 63,63 | 36,76 | 23,32 | 16,33 | 13,11 |
| GEP 150-210-2 | GEP 210-150-2 | 65,91 | 38,94 | 25,29 | 18,73 | 15,40 |
| GEP 210-300-2 | GEP 300-210-2 | 71,95 | 45,07 | 31,43 | 24,77 | 21,53 |
| GEP 300-420-2 | GEP 420-300-2 | 81,94 | 55,28 | 41,84 | 34,86 | 31,64 |
| GEP 105-105-2 | | 63,31 | 36,44 | 23,00 | 16,01 | 12,79 |
| GEP 150-150-2 | | 64,11 | 37,23 | 23,80 | 16,81 | 13,59 |
| GEP 210-210-2 | | 68,90 | 42,03 | 28,60 | 21,61 | 18,38 |
| GEP 300-300-2 | | 76,11 | 49,23 | 35,80 | 28,82 | 25,60 |
| Add-ons to hardplastic signs | | 1-4 ea. | 5-9 ea. | 10-24 ea. | 25-49 ea. | 50+ ea. |
| GEP-T | Doublesided tape | 3,90 | 2,46 | 1,36 | 0,79 | 0,53 |
| GEP-M | Magnetic tape | 3,90 | 2,46 | 1,36 | 0,79 | 0,53 |
| GEP-F | Foam tape | 3,90 | 2,46 | 1,36 | 0,79 | 0,53 |

GEA

Assembled aisle signs on aluminum



- ≡ Price per unit
- △ Available in single or double sided assembly
- Incl. 4 holes in each corner for assembly
- Available in multiple colours

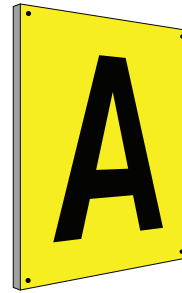

| Art.no (L x H) | Art.no (L x H) | 1-4 ea. | 5-9 ea. | 10-24 ea. | 25-49 ea. | 50+ ea. |
|----------------------------------|------------------|----------------|----------------|------------------|------------------|----------------|
| GEA 105-150-1 | GEA 150-105-1 | 59,96 | 33,09 | 19,86 | 12,77 | 9,44 |
| GEA 150-210-1 | GEA 210-150-1 | 63,88 | 37,01 | 23,57 | 16,59 | 13,36 |
| GEA 210-300-1 | GEA 300-210-1 | 68,05 | 41,18 | 27,96 | 20,86 | 17,53 |
| GEA 300-420-1 | GEA 420-300-1 | 80,09 | 53,22 | 39,57 | 32,90 | 29,15 |
| GEA 105-105-1 | | 59,78 | 32,90 | 19,47 | 12,48 | 9,26 |
| GEA 150-150-1 | | 62,46 | 35,59 | 22,15 | 15,16 | 11,94 |
| GEA 210-210-1 | | 66,67 | 39,80 | 26,36 | 19,37 | 16,15 |
| GEA 300-300-1 | | 74,27 | 47,39 | 33,96 | 26,98 | 23,76 |
| Double-sided assembly | | | | | | |
| GEA 105-150-2 | GEA 150-105-2 | 63,30 | 36,43 | 23,10 | 16,12 | 12,79 |
| GEA 150-210-2 | GEA 210-150-2 | 67,97 | 41,10 | 27,34 | 20,78 | 17,45 |
| GEA 210-300-2 | GEA 300-210-2 | 74,79 | 48,34 | 34,69 | 27,49 | 24,27 |
| GEA 300-420-2 | GEA 420-300-2 | 90,21 | 63,66 | 50,22 | 43,23 | 40,01 |
| GEA 105-105-2 | | 62,91 | 36,04 | 22,62 | 15,63 | 12,40 |
| GEA 150-150-2 | | 65,83 | 38,96 | 25,52 | 18,53 | 15,31 |
| GEA 210-210-2 | | 72,11 | 45,23 | 31,80 | 24,82 | 21,59 |
| GEA 300-300-2 | | 82,52 | 55,65 | 42,21 | 35,22 | 32,00 |
| Add-ons to aluminum signs | | 1-4 ea. | 5-9 ea. | 10-24 ea. | 25-49 ea. | 50+ ea. |
| GEA-T | Doublesided tape | 3,90 | 2,46 | 1,36 | 0,79 | 0,53 |
| GEA-M | Magnetic tape | 3,90 | 2,46 | 1,36 | 0,79 | 0,53 |
| GEA-F | Foam tape | 3,90 | 2,46 | 1,36 | 0,79 | 0,53 |

TVA

Printed angled holder with self-adhesive tape



- ≡ Price per unit
- △ With angle 27° or 45°
- Requires add-on assembly (MONT. 01)



| Art.no (L x H) | Art.no (L x H) | 1-24 ea. | 25-99 ea. | 100-249 ea. | 250-499 ea. | 500+ ea. |
|----------------|-------------------|----------|-----------|-------------|-------------|----------|
| GE 400-70 | | 5,63 | 3,72 | 2,77 | 2,19 | 2,00 |
| TVA 400-70 V27 | TVA 400-70 V45 | 7,50 | 4,31 | 2,71 | 1,76 | 1,44 |
| GE 500-70 | | 6,06 | 4,16 | 3,20 | 2,63 | 2,44 |
| TVA 500-70 V27 | TVA 500-70 V45 | 7,59 | 4,39 | 2,80 | 1,84 | 1,52 |
| GE 600-70 | | 6,49 | 4,57 | 3,62 | 3,04 | 2,86 |
| TVA 600-70 V27 | TVA 600-70 V45 | 7,81 | 4,62 | 3,02 | 2,06 | 1,74 |
| GE 700-70 | | 6,91 | 5,00 | 4,04 | 3,48 | 3,29 |
| TVA 700-70 V27 | TVA 700-70 V45 | 8,01 | 4,82 | 3,22 | 2,27 | 1,95 |
| GE 800-70 | | 7,43 | 5,52 | 4,56 | 3,99 | 3,80 |
| TVA 800-70 V27 | TVA 800-70 V45 | 8,21 | 5,02 | 3,43 | 2,47 | 2,15 |
| MONT. 01 | Add-on Assembling | 1,32 | 1,12 | 1,07 | 1,03 | 0,99 |

GET

Signs, holders and labels customized to be used with ceilings and gates.



- ≡ Price per unit
- △ Available in multiple executions
- Incl. 4 holes in each corner for assembly



The four-sided ceiling sign is delivered unassembled together with angled lists.

| Art.no (L x H) | Product | 1-3 pack | 4-9 pack | 10-24 pack | 25-49 pack | 50+ pack |
|-----------------|----------------------|----------|----------|------------|------------|----------|
| GET 500-500-1 | Sign, 1-sided | 180,85 | 62,23 | 47,34 | 38,83 | 35,64 |
| GET 500-700-1 | Sign, 1-sided | 189,89 | 71,28 | 56,38 | 47,34 | 44,68 |
| GET 600-420-1 | Sign, 1-sided | 185,11 | 66,49 | 51,60 | 43,09 | 39,79 |
| GET 700-500-1 | Sign, 1-sided | 189,89 | 71,28 | 56,38 | 47,34 | 44,68 |
| GET 1035-1000-1 | Sign, 1-sided | 229,26 | 110,64 | 96,28 | 87,23 | 84,04 |
| GET 1090-1000-1 | Sign, 1-sided | 230,85 | 112,77 | 97,87 | 88,83 | 85,64 |
| GET 500-500-2 | Sign, 2-sided | 199,47 | 80,85 | 65,96 | 57,45 | 54,26 |
| GET 500-700-2 | Sign, 2-sided | 214,89 | 96,28 | 81,38 | 72,34 | 69,68 |
| GET 600-420-2 | Sign, 2-sided | 206,91 | 88,83 | 73,94 | 64,89 | 61,70 |
| GET 700-500-2 | Sign, 2-sided | 214,89 | 96,28 | 81,38 | 72,34 | 69,68 |
| GET 500-500-4 | Sign, 4-sided | 332,98 | 193,62 | 176,06 | 165,96 | 162,23 |
| GET 500-700-4 | Sign, 4-sided | 379,26 | 239,89 | 222,34 | 212,23 | 208,51 |
| GET 700-500-4 | Sign, 4-sided | 368,62 | 229,26 | 211,70 | 201,60 | 197,87 |
| GE 610-450 | Vinyl label | 137,23 | 39,89 | 27,66 | 20,21 | 17,55 |
| GEA 610-450-1 | Sign, 1-sided, metal | 267,55 | 96,81 | 75,00 | 62,23 | 57,98 |

Suspension system

| Art.no | Product | 1-3 pack | 4-9 pack | 10-24 pack | 25-49 pack | 50+ pack |
|----------|--|----------|----------|------------|------------|----------|
| OKS 1001 | Hanger for information holder, cc 250 mm | 9,89 | 8,83 | 7,77 | 6,70 | 5,64 |
| OKS 2001 | Hanging tool telescope, 1.0 to 1.7 meter | 42,02 | 40,96 | 39,89 | 38,83 | 37,77 |
| OKS 3001 | Chain for hanging, 30 meter on roll | 74,89 | 73,83 | 72,77 | 71,70 | 70,64 |
| OKS 4001 | Hook C 40x2 mm, for ceiling, 20 ea/pack | 7,55 | 6,49 | 5,43 | 4,36 | 3,30 |
| OKS 5001 | Display pipe 2 meter, metallic, aluminum | 56,28 | 55,21 | 54,15 | 53,09 | 52,02 |
| OKS 5002 | Hook for display pipe 25 ea/pack | 28,09 | 25,96 | 23,83 | 21,70 | 19,57 |
| OKS 5003 | Jointer for display pipe, 10 ea/pack | 39,68 | 37,55 | 35,43 | 33,30 | 31,17 |



OKS 1001



OKS 3001



OKS 4001



OKS 5001

SK & GS

Unassembled aisle sign that fits the T & GE-series



- ≡ Price per unit
- △ Flat design (SK) or 90° angle design (GS)
- Self-adhesive

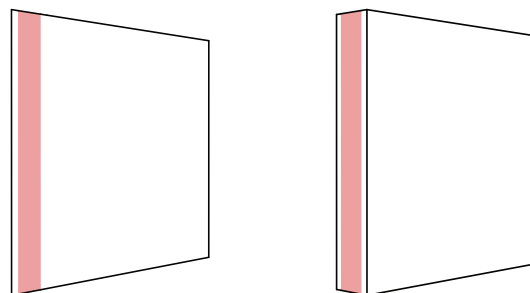

| Art.no (L x H) | 1-4 ea. | 5-9 ea. | 10-24 ea. | 25-49 ea. | 50+ ea. |
|----------------|---------|---------|-----------|-----------|---------|
| SK 75-150 | 2,97 | 2,54 | 2,33 | 2,22 | 1,90 |
| SK 150-150 | 3,17 | 2,74 | 2,53 | 2,43 | 2,11 |
| SK 100-210 | 3,17 | 2,74 | 2,53 | 2,43 | 2,11 |
| SK 200-210 | 3,51 | 3,09 | 2,87 | 2,77 | 2,45 |
| SK 210-300 | 4,07 | 3,65 | 3,44 | 3,33 | 3,01 |
| SK 300-210 | 4,63 | 4,20 | 3,99 | 3,88 | 3,56 |
| SK 420-300 | 6,89 | 6,47 | 6,26 | 6,15 | 5,83 |
| GS 75-150 | 4,34 | 3,91 | 3,70 | 3,60 | 2,85 |
| GS 150-150 | 4,52 | 4,10 | 3,88 | 3,78 | 3,03 |
| GS 100-210 | 4,52 | 4,10 | 3,88 | 3,78 | 3,03 |
| GS 200-210 | 4,86 | 4,44 | 4,22 | 4,12 | 3,37 |
| GS 210-300 | 5,27 | 4,84 | 4,63 | 4,52 | 3,78 |
| GS 300-210 | 5,79 | 5,36 | 5,15 | 5,04 | 4,30 |
| GS 420-300 | 8,68 | 8,26 | 8,04 | 7,94 | 7,19 |

GBA & GBB

Protected holder that is angled for hallways



- ≡ Price per unit
- △ For aisle
- GBA - Self-adhesive
- GBB - Magnetic

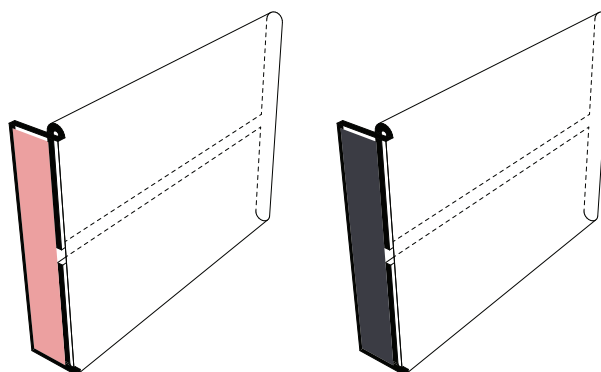

| Art.no (L x H) portrait | Art.no (L x H) landscape | 1-4 ea. | 5-9 ea. | 10-24 ea. | 25-49 ea. | 50+ ea. |
|-------------------------|--------------------------|---------|---------|-----------|-----------|---------|
| GBA 105-150 | GBA 150-105 | 5,32 | 4,79 | 4,26 | 3,72 | 3,51 |
| GBA 150-210 | GBA 210-150 | 5,53 | 5,00 | 4,47 | 3,94 | 3,72 |
| GBA 210-300 | GBA 300-210 | 6,17 | 5,64 | 5,11 | 4,57 | 4,36 |
| GBA 300-420 | | 6,91 | 6,38 | 5,85 | 5,32 | 5,11 |
| GBB 105-150 | GBB 150-105 | 7,77 | 7,23 | 6,70 | 6,17 | 4,79 |
| GBB 150-210 | GBB 210-150 | 8,40 | 7,87 | 7,34 | 6,81 | 5,43 |
| GBB 210-300 | GBB 300-210 | 9,04 | 8,51 | 7,98 | 7,45 | 6,06 |
| GBB 300-420 | | 10,96 | 10,43 | 9,89 | 9,36 | 7,98 |

Information holders

Our information holders can be used in several areas - the common thing is that they highlight the message and thereby increase the value of what you want to say.

The advantage of an information holder is that it protects the message from dust and dirt, keeps it neatly in place while still easy to change information.

Similar to other products that we manufacture, our information holders have adaptations and features for just the right use.

You can get an information holder with a magnet so it is removable, or with self-adhesive foam tape for a more permanent installation.

We have information holders with a coloured frame. Colour coding is a good aid to ensure that the information reaches the right recipient.

Our holders with coloured frames are available in several designs, for floors, for boards and so on.

Our holders are also available with a coloured frame and open front, great for documents to write directly on without the need to remove the paper/information.

We also have signs holders where the information is interchangeable and excellent for warehouse aisles where the information constantly changes with the flow.

Our information holders can be found in offices, in stores, in warehouses and in production environments.

IA & IAM

Protected to keep information free from dirt



- ≡ 10 pcs/pack
- △ For boards
- IA# - Self-adhesive foam tape
- IA#M - Magnetic

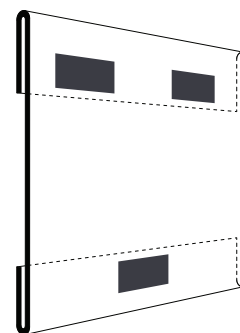
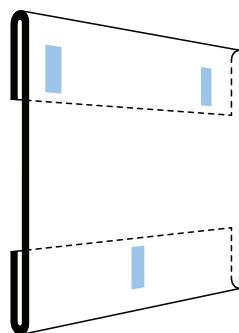

| Art.no (L x H) portrait | Art.no (L x H) landscape | 1-3 pack | 4-9 pack | 10-24 pack | 25-49 pack | 50+ pack |
|-------------------------|--------------------------|----------|----------|------------|------------|----------|
| IA6 105-150 F | IA6 150-105 F | 24,57 | 21,91 | 21,38 | 20,32 | 18,72 |
| IA5 150-210 F | IA5 210-150 F | 25,32 | 22,66 | 22,13 | 21,06 | 19,47 |
| IA4 210-300 F | IA4 300-210 F | 29,47 | 26,81 | 26,28 | 25,21 | 23,62 |
| IA3 300-420 F | IA3 420-300 F | 42,02 | 39,36 | 38,83 | 37,77 | 36,17 |
| IA6M 105-150 F | IA6M 150-105 F | 27,23 | 24,57 | 24,04 | 22,98 | 21,38 |
| IA5M 150-210 F | IA5M 210-150 F | 29,26 | 26,60 | 26,06 | 25,00 | 23,40 |
| IA4M 210-300 F | IA4M 300-210 F | 35,96 | 33,30 | 32,77 | 31,70 | 30,11 |
| IA3M 300-420 F | IA3M 420-300 F | 53,72 | 51,06 | 50,00 | 48,94 | 47,34 |

IAM - Coloured frame

Coloured frames allows you to categorize information



- ≡ 10 pcs/pack
- △ For boards
- Magnetic

Frame available in multiple colours

- Yellow
- White
- Black
- Red
- Green
- Blue

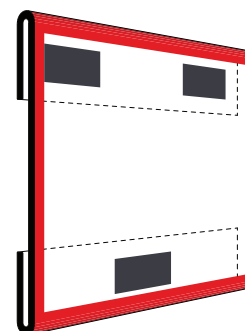

| Art.no (L x H) portrait | Art.no (L x H) landscape | 1-3 pack | 4-9 pack | 10-24 pack | 25-49 pack | 50+ pack |
|-------------------------|--------------------------|----------|----------|------------|------------|----------|
| IA5M 150-210 # F | IA5M 210-150 # F | 37,77 | 36,17 | 35,11 | 34,04 | 32,98 |
| IA4M 210-300 # F | IA4M 300-210 # F | 44,89 | 42,23 | 41,70 | 40,64 | 39,04 |
| IA3M 300-420 # F | IA3M 420-300 # F | 71,28 | 68,62 | 68,09 | 67,02 | 65,43 |

IBA & IBB

Information holder with coloured frames for boards



- ≡ 10 pcs/pack
- △ For boards
- IBA - Self-adhesive foam tape
- IBB - Magnetic

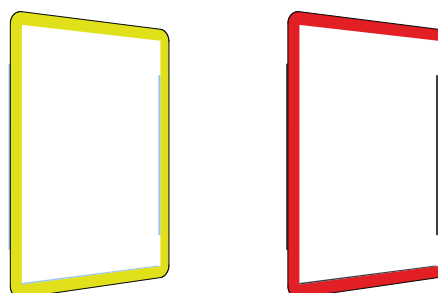

Frame available in multiple colours:

- Yellow
- White
- Red
- Green
- Blue
- Grey

| Art.no (L x H) | 1-3 pack | 4-9 pack | 10-24 pack | 25-49 pack | 50+ pack |
|-----------------|----------|----------|------------|------------|----------|
| IBA 150-210 # F | 30,43 | 27,77 | 27,23 | 26,17 | 23,51 |
| IBA 210-300 # F | 36,91 | 34,26 | 33,72 | 32,66 | 30,00 |
| IBA 300-420 # F | 51,49 | 48,83 | 48,30 | 47,23 | 44,57 |
| IBB 150-210 # F | 34,89 | 32,23 | 31,70 | 30,64 | 27,98 |
| IBB 210-300 # F | 42,55 | 39,89 | 39,36 | 38,30 | 35,64 |
| IBB 300-420 # F | 60,00 | 57,34 | 56,81 | 55,74 | 53,09 |

IBO

Information holder with open front and coloured frames



- ≡ 10 pcs/pack
- △ For boards
- Magnetic

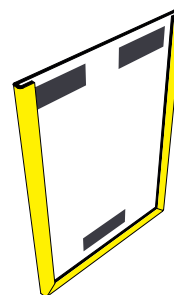

Frame available in multiple colours:

- Yellow
- Red
- Green
- Blue
- Grey

| Art.no (L x H) | 1-3 pack | 4-9 pack | 10-24 pack | 25-49 pack | 50+ pack |
|--------------------|----------|----------|------------|------------|----------|
| IBO 210-300-12 # F | 86,17 | 83,51 | 82,98 | 81,91 | 79,26 |
| IBO 300-420-12 # F | 94,15 | 91,49 | 90,96 | 89,89 | 87,23 |

IBF & IBK

Information holder for floors with broad frames



- ≡ 10 pcs/pack
- △ For floor
- Self-adhesive
- IBF has four closed sides, IBK has three closed sides

Frame available in multiple colours:

- Yellow
- White
- Red
- Green
- Blue
- Clear
- Yellow/black stripes

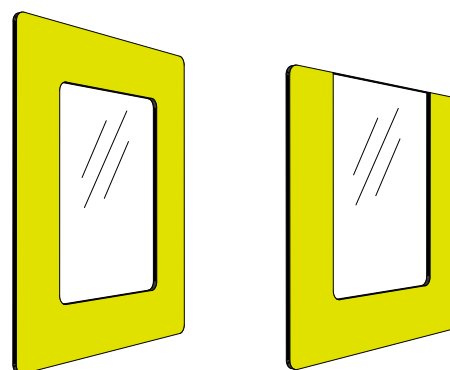

| Art.no (L x H) | 1-3 pack | 4-9 pack | 10-24 pack | 25-49 pack | 50+ pack |
|-----------------|----------|----------|------------|------------|----------|
| IBF 150-210 # F | 49,68 | 47,02 | 46,49 | 45,43 | 42,77 |
| IBF 210-300 # F | 60,85 | 58,19 | 57,66 | 56,60 | 53,94 |
| IBK 150-210 # F | 47,87 | 45,21 | 44,68 | 43,62 | 40,96 |
| IBK 210-300 # F | 60,64 | 57,98 | 57,45 | 56,38 | 53,72 |

IBS

Information holder for floor, pointing arrow



- ≡ 10 pcs/pack
- △ For floor
- Self-adhesive
- Unique shape of arrow

Frame available in multiple colours:

- Yellow
- White
- Red
- Green
- Blue
- Clear
- Yellow/black stripes

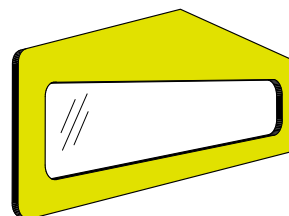

| Art.no (L x H) | 1-3 pack | 4-9 pack | 10-24 pack | 25-49 pack | 50+ pack |
|-----------------|----------|----------|------------|------------|----------|
| IBS 320-100 # F | 35,32 | 32,66 | 32,13 | 31,06 | 28,40 |

PF

Plastic pockets with eyelet holes for hanging



- ≡ Price per unit
- △ Anti-reflective surface
- CC on eyelet according to spec.
- PF with CC 250 mm fits OKS 1001 (page 42)

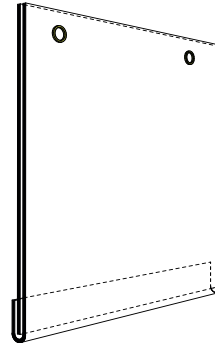

| Art.no (L x H) | Eyelet CC | 1-24 ea. | 25-99 ea. | 100-249 ea. | 250-499 ea. | 500+ ea. |
|----------------|---------------------|----------|-----------|-------------|-------------|----------|
| PF 210-300 D4 | 150 mm | 8,53 | 5,34 | 3,74 | 2,79 | 2,47 |
| PF 300-210 D4 | 250 mm | 8,51 | 5,32 | 3,72 | 2,77 | 2,45 |
| PF 300-420 D4 | 250 mm | 9,78 | 6,59 | 4,99 | 4,03 | 3,71 |
| PF 420-300 D4 | 250 mm | 9,85 | 6,66 | 5,06 | 4,11 | 3,79 |
| PF 420-600 D4 | 250 mm | 12,20 | 9,01 | 7,41 | 6,46 | 6,14 |
| PF 600-420 D4 | 350 mm | 17,05 | 12,13 | 9,67 | 8,19 | 7,70 |
| PF 500-700 D4 | 320 mm | 13,69 | 10,50 | 8,90 | 7,95 | 7,63 |
| PF 700-500 D4 | 500 mm | 18,34 | 13,43 | 10,97 | 9,49 | 9,00 |
| PF 700-1000 D4 | 500 mm | 23,35 | 18,43 | 15,97 | 14,49 | 14,00 |
| PF 1000-700 D4 | 400/960 mm (4 eye.) | 23,55 | 18,63 | 16,17 | 14,69 | 14,20 |

PL

Plastic pockets for holders and suspension



- ≡ Price per unit
- △ Anti-reflective surface
- ∅ Available with holes for hanging

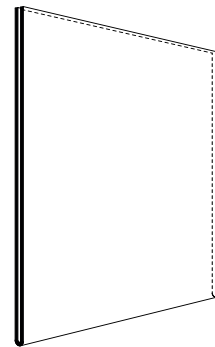

| Art.no (L x H) | 1-24 ea. | 25-99 ea. | 100-249 ea. | 250-499 ea. | 500+ ea. |
|----------------|----------|-----------|-------------|-------------|----------|
| PL 150-210 D4 | 5,67 | 3,34 | 2,18 | 1,48 | 1,24 |
| PL 210-150 D4 | 5,66 | 3,33 | 2,16 | 1,47 | 1,23 |
| PL 210-300 D4 | 6,09 | 3,77 | 2,60 | 1,90 | 1,67 |
| PL 300-210 D4 | 6,09 | 3,77 | 2,60 | 1,90 | 1,67 |
| PL 300-420 D4 | 6,97 | 4,65 | 3,48 | 2,79 | 2,55 |
| PL 420-300 D4 | 6,97 | 4,65 | 3,48 | 2,79 | 2,55 |

EDB

Plastic pocket for i.a. insert into shelf edge strip



- ≡ Price per unit
- △ Anti-reflective surface

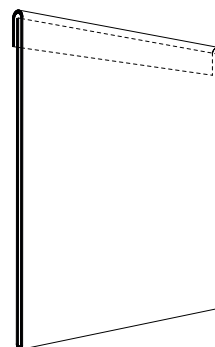

| Art.no (L x H) | 1-24 ea. | 25-99 ea. | 100-249 ea. | 250-499 ea. | 500+ ea. |
|----------------|----------|-----------|-------------|-------------|----------|
| EDB 150-210 D4 | 7,48 | 4,29 | 2,69 | 1,73 | 1,41 |
| EDB 210-150 D4 | 7,49 | 4,30 | 2,70 | 1,74 | 1,43 |
| EDB 210-300 D4 | 7,87 | 4,68 | 3,09 | 2,13 | 1,81 |
| EDB 300-210 D4 | 7,90 | 4,71 | 3,12 | 2,16 | 1,84 |
| EDB 300-420 D4 | 9,01 | 5,82 | 4,22 | 3,27 | 2,95 |
| EDB 420-300 D4 | 9,01 | 5,82 | 4,22 | 3,27 | 2,95 |

KPP

Mounted around pallet footing, fastened with velcro. Combine together with a labelholder or a vinyl label, adhere directly on the holder.



- ≡ 50 pcs/pack
- △ For pallet foot
- Available only in yellow plastic

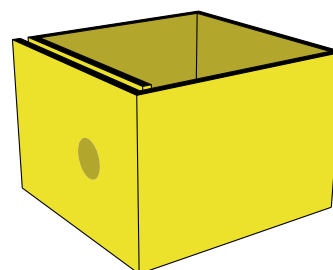

| Art.no (L x H) | 1-4 ea. | 5-9 ea. | 10-24 ea. | 25-49 ea. | 50+ ea. |
|------------------|---------|---------|-----------|-----------|---------|
| KPP 100-75-0,5 Y | 6,06 | 4,47 | 3,94 | 3,40 | 2,87 |
| KPP 145-75-0,5 Y | 6,17 | 4,57 | 4,04 | 3,51 | 2,98 |

Card holders

In order to easily mark the contents of pallets with collars, we offer a number of different holders. Our card holders are made of transparent plastic, which makes them very durable and easy to handle when changing the information frequently.

If you want to facilitate the exchange of information or make notes about completed work, a card holder with an open front works best (KPB).

If you want to protect the information from dirt and dust, a closed holder works best. To make it easier to change labels, there is a thumb grip on its back (KPS).

If a longer durability of the card holder is required, it is available in thicker material (KPA).

If you have a larger area with pallets, the pallet collar markings needs to be lifted up for better readability and overview. Our card holder in vertical design fits here (KPC).

Within 5S/lean, colour is used to signal e.g. approved or blocked goods. We have a two coloured pallet collar holder which is reversible to signal a green side or a red side (KPK).

Sometimes you want to protect your contents within pallets with pallet collars from dirt, dust and splashes/spills, this is easily done with a large transparent plastic sheet - available in two sizes for EUR-pallet and EUR-half-pallet (TPL).

With our own production, we have the opportunity to go beyond the standard format and design of the holders. Contact us and we will help you.

KPB

Card holder with open front



- ≡ 50 pcs/pack
- △ For pallet collars
- △ V90 - Has a 90° degree tab for insertions

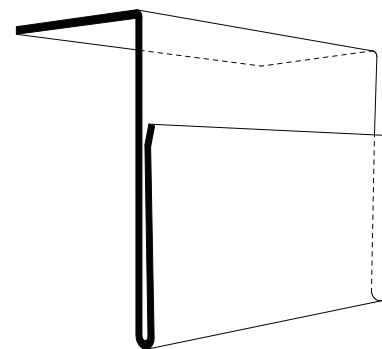
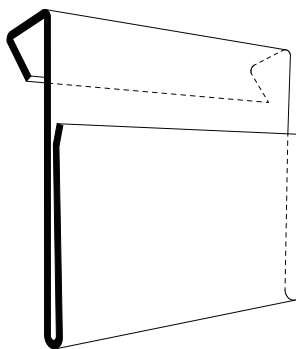

| Art.no (L x H) | 1-3 pack | 4-9 pack | 10-24 pack | 25-49 pack | 50+ pack |
|-------------------|----------|----------|------------|------------|----------|
| KPB 210-155 F | 87,23 | 84,57 | 83,51 | 82,45 | 79,79 |
| KPB 300-210 F | 162,77 | 160,11 | 159,04 | 157,98 | 155,32 |
| KPB 210-150 V90 F | 126,06 | 123,40 | 122,34 | 121,28 | 118,62 |
| KPB 300-210 V90 F | 177,13 | 174,47 | 173,40 | 172,34 | 169,68 |

KPS

Card holder with protective front



- ≡ 50 pcs/pack
- △ For pallet collars
- △ V90 - Has a 90° degree tab for insertions

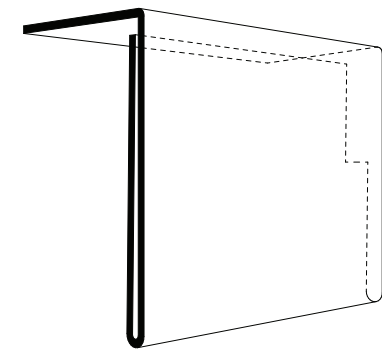
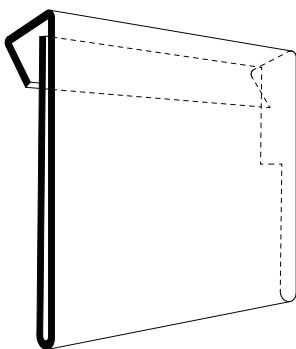

| Art.no (L x H) | 1-3 pack | 4-9 pack | 10-24 pack | 25-49 pack | 50+ pack |
|-------------------|----------|----------|------------|------------|----------|
| KPS 210-155 F | 82,45 | 79,79 | 78,72 | 77,66 | 75,00 |
| KPS 300-210 F | 114,89 | 112,23 | 111,17 | 110,11 | 107,45 |
| KPS 210-160 V90 F | 94,15 | 91,49 | 90,43 | 89,36 | 86,70 |
| KPS 300-210 V90 F | 141,49 | 138,83 | 137,77 | 136,70 | 134,04 |

KPL & KPA

Card holder with open back



- ≡ 50 pcs/pack
- △ For pallet collars
- KPA is of thicker material

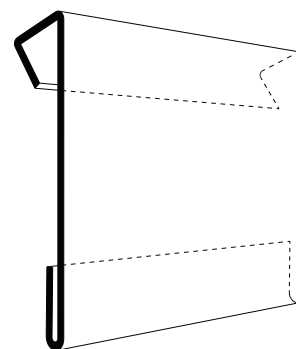
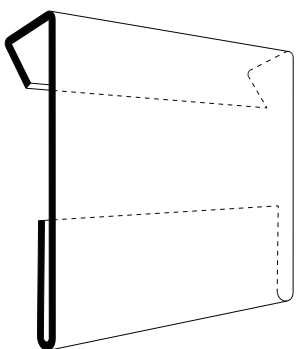

| Art.no (L x H) | 1-3 pack | 4-9 pack | 10-24 pack | 25-49 pack | 50+ pack |
|----------------|----------|----------|------------|------------|----------|
| KPL 210-155 F | 69,68 | 67,02 | 65,96 | 64,89 | 62,23 |
| KPA 210-155 F | 77,66 | 75,00 | 73,94 | 72,87 | 70,21 |

KPC

Card holder for pallet frame, raised design



≡ 50 pcs/pack
 △ For pallet collars

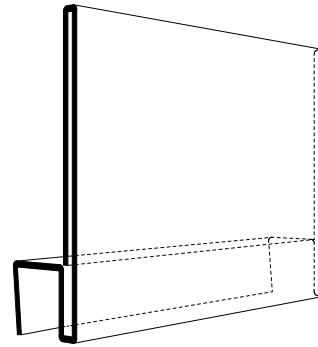

| Art.no (L x H) | 1-3 pack | 4-9 pack | 10-24 pack | 25-49 pack | 50+ pack |
|----------------|----------|----------|------------|------------|----------|
| KPC 210-150 F | 147,34 | 144,68 | 143,62 | 142,55 | 139,89 |
| KPC 300-210 F | 196,81 | 194,15 | 193,09 | 192,02 | 189,36 |

KPK

Marking for pallet frame with different colour elements



≡ Price per unit
 △ For pallet collars

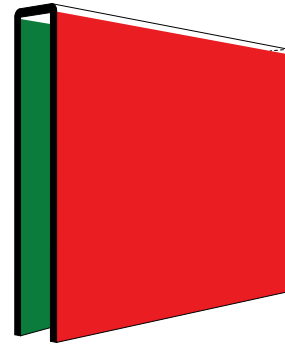

| Art.no (L x H) | Colour | 1-4 ea. | 5-9 ea. | 10-24 ea. | 25-49 ea. | 50+ ea. |
|----------------|-----------|---------|---------|-----------|-----------|---------|
| KPK 210-150 RG | Red/Green | 5,53 | 3,94 | 3,40 | 2,87 | 2,34 |

SHK

Sign holder for pallet collars and well containers



≡ Price per unit
△ Anti-reflective surface

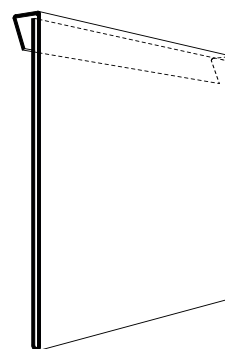

| Art.no (L x H) | 1-24 ea. | 25-99 ea. | 100-249 ea. | 250-499 ea. | 500+ ea. |
|------------------|----------|-----------|-------------|-------------|----------|
| SHK 150-210 D4-7 | 7,72 | 4,53 | 2,94 | 1,98 | 1,66 |
| SHK 210-150 D4-7 | 7,49 | 4,30 | 2,70 | 1,74 | 1,43 |
| SHK 210-300 D4-7 | 7,90 | 4,71 | 3,12 | 2,16 | 1,84 |
| SHK 300-210 D4-7 | 8,16 | 4,97 | 3,37 | 2,41 | 2,10 |
| SHK 300-420 D4-7 | 10,51 | 6,85 | 5,03 | 3,94 | 3,56 |
| SHK 420-300 D4-7 | 10,51 | 6,85 | 5,03 | 3,94 | 3,56 |
| SHK 500-700 D4-7 | 14,74 | 10,69 | 8,66 | 7,45 | 7,03 |
| SHK 700-500 D4-7 | 16,69 | 11,71 | 9,22 | 7,73 | 7,23 |

TPL

Anti-reflective cover plastic, facilitates overview of pallet content



≡ Price per unit
△ For pallets with collars



| Art.no (L x H) | 1-4 ea. | 5-9 ea. | 10-24 ea. | 25-49 ea. | 50+ ea. |
|-----------------|---------|---------|-----------|-----------|---------|
| TPL 750-575 D4 | 11,91 | 7,66 | 5,00 | 3,40 | 2,87 |
| TPL 1150-750 D4 | 14,68 | 10,43 | 7,77 | 6,17 | 5,64 |

DS

Menu holder, L-stand, helps message reach a readable height



≡ Price per unit
△ Is of thicker material

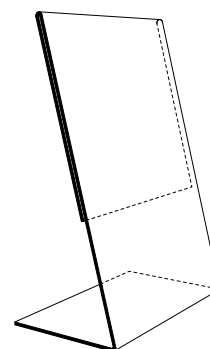

| Art.no (L x H) | 1-4 ea. | 5-9 ea. | 10-24 ea. | 25-49 ea. | 50+ ea. |
|----------------|---------|---------|-----------|-----------|---------|
| DS 105-150 | 10,11 | 8,51 | 7,45 | 6,91 | 6,38 |
| DS 150-210 | 11,17 | 9,57 | 8,51 | 7,98 | 7,45 |
| DS 210-300 | 14,36 | 12,77 | 11,70 | 11,17 | 10,64 |
| DS 300-210 | 14,36 | 12,77 | 11,70 | 11,17 | 10,64 |
| DS 300-420 | 18,62 | 17,02 | 15,96 | 15,43 | 14,89 |
| DS 420-300 | 18,62 | 17,02 | 15,96 | 15,43 | 14,89 |

MS

Menu holder, T-stand, protects and show information on both sides



≡ Price per unit
△ Is of thicker material

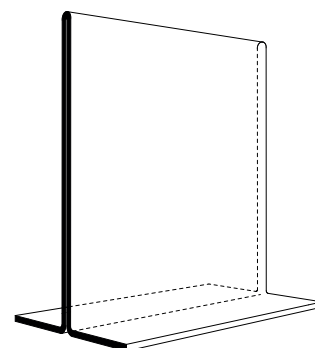

| Art.no (L x H) | 1-4 ea. | 5-9 ea. | 10-24 ea. | 25-49 ea. | 50+ ea. |
|----------------|---------|---------|-----------|-----------|---------|
| MS 105-150 | 11,70 | 10,11 | 9,04 | 8,51 | 7,98 |
| MS 150-210 | 12,77 | 11,17 | 10,11 | 9,57 | 9,04 |
| MS 210-300 | 15,43 | 13,83 | 12,77 | 12,23 | 11,70 |
| MS 300-210 | 15,43 | 13,83 | 12,77 | 12,23 | 11,70 |
| MS 300-420 | 19,68 | 18,09 | 17,02 | 16,49 | 15,96 |
| MS 420-300 | 19,68 | 18,09 | 17,02 | 16,49 | 15,96 |

Lean Production

Create order in your production. Mark where carts and staff should stand/walk. Lean is also about whiteboards like root-analys or s.a.f.e.r.

GEC

Printed self-adhesive vinyl that you apply on a whiteboard. The vinyl itself has a whiteboard laminate



- ≡ Price per unit
- △ Available in multiple types and sizes

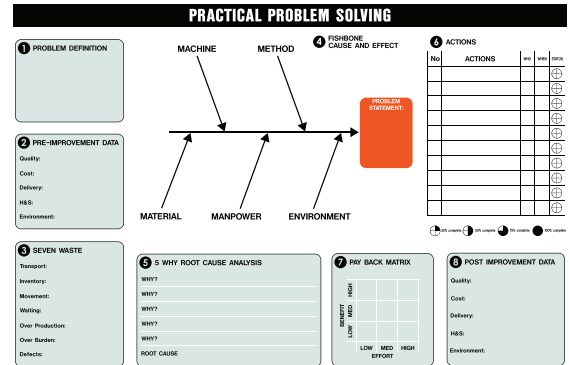

| Art.no (L x H) | Product | 1 ea. | 2 ea. | 3 ea. | 4 ea. | 5+ ea. |
|----------------|----------------------------------|--------|--------|--------|--------|--------|
| GEC 1200-900 | Whiteboard vinyl, printed panels | 325,53 | 256,38 | 233,51 | 221,81 | 214,89 |
| GEC 900-600 | Whiteboard vinyl, printed panels | 232,98 | 163,83 | 140,96 | 129,26 | 122,34 |
| GEC 150-210 | Whiteboard vinyl, printed panels | 144,68 | 75,53 | 52,66 | 40,96 | 34,04 |

VSM

Magnetic labels for you to visualise production



- ≡ Price per unit
- △ Available in multiple packs and symbols

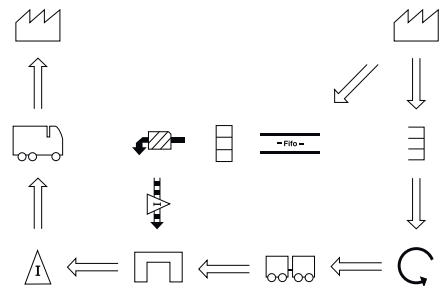

| Art.no | Product | 1 ea. | 2 ea. | 3 ea. | 4 ea. | 5+ ea. |
|---------|--|--------|--------|--------|--------|--------|
| VSM 130 | Kit for board, 74x105 mm, magnetic, 26x5 ea. | 237,23 | 152,66 | 124,47 | 110,11 | 102,13 |
| VSM 5 | Part of a kit for board, 74x105 mm, 5 ea. acc. spec. | 144,15 | 73,40 | 50,00 | 38,30 | 31,38 |

KT

Our kanban kit contains a collection of ours products for building your own kanban board



≡ Price per unit

| Art.no | Product | 1 ea. | 2 ea. | 3 ea. | 4 ea. | 5+ ea. |
|--------|------------|--------|--------|--------|--------|--------|
| KT | Kanban kit | 397,34 | 310,64 | 281,91 | 267,55 | 259,04 |

Our kanban kit contains these products:

- 60 pcs Label holders 150x170 mm, angle 27°, magnetic, PETG - Artnr: **TVB 150-170-1,5 V27**
- 1 pcs Informations holder 300x210 mm, magnetic, landscape A4, white - From artnr: **IA4M 300-210 W F**
- 1 pcs Informations holder 300x210 mm, magnetic, landscape A4, blue - From artnr: **IA4M 300-210 B F**
- 1 pcs Informations holder 300x210 mm, magnetic, landscape A4, yellow - From artnr: **IA4M 300-210 Y F**
- 1 pcs Magnetic band 200x50 mm, 0,6 mm thick, white - From artnr: **MT 20000-50 W**
- 1 pcs Magnetic band 200x50 mm, 0,6 mm thick, blue - From artnr: **MT 20000-50 B**
- 1 pcs Magnetic band 200x50 mm, 0,6 mm thick, yellow - From artnr: **MT 20000-50 Y**

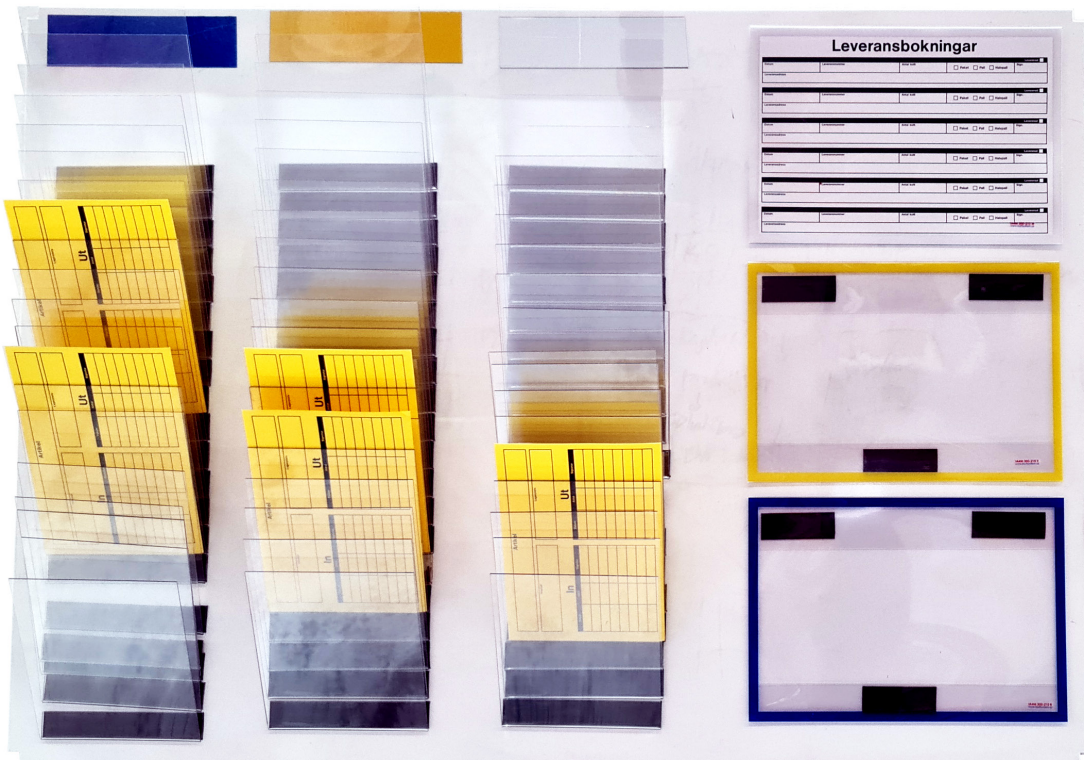

Assembly suggestion

Accessories

Accessories for surface cleaning and mounting vinyl.
Also grippers for removing adhesive vinyl.



≡ Price per unit

| Art.no | Product | 1 ea. | 2 ea. | 3 ea. | 4 ea. | 5+ ea. |
|------------|--|-------|-------|-------|-------|--------|
| GE MIP1000 | ImagePerfect Surface Cleaner Pro, 1 Liter Spray bottle | 37,81 | 35,69 | 34,62 | 33,56 | 32,50 |
| GE-LG | Lil-gripper, vinyl remover, plastic | 32,98 | 30,86 | 29,79 | 28,73 | 24,47 |
| GE-LGB | Lil-gripper, 100 st blades, plastic | 85,05 | 82,93 | 81,86 | 80,80 | 76,54 |



GE MIP1000



GE-LG



GE-LGB

News

GEF

This year we have some news for our self-adhesive vinyl selection. One of these is vinyl labels for freezers. The label has a custom adhesive that attaches and hardens at a working temperature of -5 degrees celsius. Excellent for mounting on an active freezer.

The product can be viewed on the page 25

RME

Another vinyl news is a label suitable for low-energy surfaces.

Surfaces that have low energy are for example coated matte surfaces, porous surfaces, greasy surfaces and surfaces that our standard vinyl (GE) have difficulty to adhere on permanently. With this vinyl, you can attach the label directly on cardboard, wood, plastic bins and matte/structured powder coating.

The product can be viewed on the page 26

TVA

Not all pallet rack beams are straight/flat, some such as Z-beam or I-beam have angled structure, this means that our vinyl labels do not get the ideal angle for readability.

The solution is TVA, which is a holder that is angled 27 or 45 degrees. Our vinyl is attached to this angled holder and the angle makes the marking readable even at very high heights.

The product can be viewed on the page 41

IBS

A requested product that is based from our IBF product line. This is an information holder for the floor, designed as an arrow and keeps the information permanently in place. Excellent for larger warehouse areas with pallets.

The product can be viewed on the page 47

DS & MS

Menu holders, we have two models;

The L-stand that will get the message up to a readable height.

The T-stand protects and show information from both sides.

The product can be viewed on the page 55



Kortsystem i Gislaved AB
Verkstadsgatan 6 • Box 277 • SE-332 25 Gislaved
Telefon +46(0)371-22 24 44
info@kortsystem.se • www.kortsystem.se